

FOOTNOTES

VOLUME 66 • NUMBER 4

DECEMBER 2015



Published by the Square and Folk Dance Federation of Washington

FOOTNOTES STAFF

Margaret Miller.....Co-Editor
 Scott & Shirley Marriner.....Co-Editor,
 Publisher & Graphic Design
 Kay & Roger Mahan.....Business Manager
 George & Sharon Broom.....Advertising Mgr
 Mickey & Barbara Franz.....
Education & Leadership Seminar
 Rob & Vicki Krum.....Square Dance Editor
 Joyce Sebree.....Round Dance Editor
 Richard & Barbara Snyder.....
Membership & Insurance
 Karen & Dave Reichardt.....Sewing Editor
 Tiffany & Matthew Richard.....
 Youth Coordinators
 Kathy Rooney.....Solo Editor
 Inland Saxum Printing LLC., Walla Walla, WA
Printers

STATE OFFICERS

Gene & Tanya Currier.....President
 Margaret & Kris Kiser.....Vice-President
 Tom & Donna Rhode.....Treasurer
 Bev & Gordon Mustard.....Recording Sec'y
 Lu & Bob Simmons.....Corresponding Sec'y

Subscribers: Please Check your mailing label for your FOOTNOTES expiration date. That is the month your last issue will arrive if you don't renew on time. One month ahead is best. Also, check to be sure your address is exactly right and send us your corrections.

PUBLICATION & POLICY STATEMENT
 FOOTNOTES (UPS 1733330) is published monthly except July & August at 10 N. 7th Avenue, Walla Walla, WA 99362-1865 by the Square and Folk Dance Federation of Washington, a Non-Profit Corporation. Non-Profit Standard Postage paid at College Place, WA 99324. Subscription rate is \$15.00 per year. Canadians pay \$20.00 (US) per year. In the event that FOOTNOTES ceases to be printed, there will be no reimbursement of subscription payments. The editors reserve the right to condense, omit or rewrite all or any part of material received for publication and exercise their discretion in the acceptance of any material. The right to reprint articles or art work included in FOOTNOTES is given provided credit is given to Footnotes. For further information call 509-823-4675.

POSTMASTER
 Send address changes to:
 Square & Folk Dance Federation
 P O Box 11160
 Yakima, WA 98909-2160

CONTENTS

Table of Contents.....1
 Our Advertisers.....2
 Coming Events.....3
 The Gavel.....4
 We Remember.....5
 From Your Editor • Maggie.....6
 From Your Editor • Scotty.....7
 January 2016 State meeting.....8
 Membership & Insurance.....10
 48th Leadership Seminar - 2016.....12
 Youth Coordinator.....14
 Squarely Speaking.....15
 Round Out Your Life.....16
 Sew Together.....18
 Solo Corner.....20
 2016 Festival "Tall Timber Calling".....21
 Club News Begins.....22
 Blue Mountain Council.....22
 Central Area Council.....24
 Central Puget Sound Council.....26
 Evergreen Council.....28
 Mount Baker Council.....30
 North Central Council.....38
 North Olympic Council.....41
 Peninsula Council.....42
 Rainier Council.....44
 Sou'Wester Council.....48
 Spokane Council.....54



December 5, 2015

7 pm to 9:30 pm

Yakima Square & Round Dance Center

Caller

Tom Clymer

Cuer

Jim Dobbs

2 pm - 4 pm Plus Dance w/ Rounds

5:30 pm – Roast Beef Dinner

7pm - Pre-Rounds

7:30 pm – 9:30 pm Mainstream
 Dance w/ Rounds

9:30 pm Refreshments



Load the Pot -
 prize drawings

Roast Beef (w/ baked potato) dinner \$10/person (kids at reduced rates). Please RSVP for dinner, so we can estimate numbers. Plus Dance \$3/ person. Mainstream Dance \$8/person (kids at reduced rates). Yakima Square & Round Dance Center 207 East Charron Road, Moxee, Washington. Yakima Gateswinger's event. RSVP 509-966-4356



DECEMBER COVER

Shirley's Christmas Cactus bringing you Season's Greetings from your FOOTNOTES Staff

Cover Photo & Design by Scott Marriner

PLEASE THANK OUR ADVERTISERS

Blue Agate Squares.....	25	Susan Morris.....	36
Blue Mountain Council.....	23	SwingNuts.....	60
Bonney Lads 'N' Lassies.....	47	Swinging Squares Plus.....	47
Buzzin' Bees.....	29	Tiger Mountain Engraving.....	14
Cougar Squares.....	47	Twin City Twirlers.....	59
Craig Abercrombie.....	3	Whirlybirds.....	36
Flutterwheels.....	47		
Gateswingers.....	25 & IFC		
Harbor Haylofters.....	59		
Mt. Baker Council.....	35		
Muddy Frogs.....	23		
North Central Council.....	43		
OASDI.....	IBC		
Peninsula Council.....	19		
Petticoat Junction.....	OBC		
Pi-R-Squares.....	36		
Prairie Shufflers.....	29		
Prairie Steppers.....	59		
R Square D.....	47		
Rainier Council.....	37		
Round-A-Bouts.....	47		
Ruff & Ruffles.....	47		
Silhouette Dancers.....	25		
Silver Stars.....	29		
South Sound Singles.....	47		
Sou'Wester Council.....	53		
Spokane Area Council.....	11		
Square One Plus.....	47		
Stardust Dancers.....	47		

IFC = inside front cover • IBC = inside back cover • OBC = outside back cover

FOOTNOTES
PO Box 11160
Yakima, WA 98909- 2160
footnotes_wa@yahoo.com
509-522-2716

Mechanical Requirements Advertising Rates, per issue

Full page 4.5" x 7.5".....	\$55.00
Half page 4.5" x 3.7183".....	34.00
Quarter page (landscape) 4.5" x 1.8138".....	18.00
Quarter page (portrait) 2.1667" x 3.7183".....	18.00
One Column Inch ad 2.1667" x 1.0".....	7.00
One Column Inch ad 2.1667" x 1.0" (5 or more, one change free).....	6.00
Two Inch ad (landscape) 4.5" x 1.0".....	14.00
(5 or more, one change free).....	12.00
Two Inch ad (portrait) 2.1667" x 2.0833".....	14.00
(5 or more, one change free).....	12.00
Copy Change Monthly***.....	2.00
Copy Change Permanent.....	No Charge

NOTE: ***\$2.00 Copy Change Monthly charge applies to all ads quarter page and smaller with the exception of one inch ads, which are \$1.00 per month.

AD DEADLINE: 1st of each month preceding the month of publication.

Payment due prior to publication for all ads

Advertise
your awesome
Club, Dance, Business
in
FOOTNOTES
contact our sales representatives:
George & Sharon Broom
206.842.5147
geobrooms@aol.com
THEY WORK FOR PEANUTS!

COMING EVENTS

www.squaredance-wa.org

January 2016 State Federation Business Meeting
Rose Valley Grange • Kelso, Washington
Hosted by Sou'Wester Council
January 16, 2016

64th Washington State Square and Folk Dance Festival
"Tall Timber Calling"
Longview, Washington
June 17 - 18, 2016

65th National Square Dance Convention®
Des Moines, Iowa
June 22 - 25, 2016

48th Annual Education & Leadership Seminar
Circle 8 Ranch
Cle Elum, Washington
July 8, 9, & 10, 2016

Have Fun Dancing To CRAIG ABERCROMBIE

Basic B-51

R Square D-Dec 11-7:30PM
Christmas Toy Dance
Kelso Senior Center, Kelso, WA

MS

Fairway Village Squares
Every Monday-12:30PM
Fairway Village Ballroom, Vancouver, WA
Dec 21-Christmas Dance
Dec 28-DARK

Woodinville Square Crows – Dec 4
Christmas Dance
Sammamish Grange, Woodinville, WA

Corvallis Squares-Dec 12-7:00PM
Christmas Dance
First Congregational Church, Corvallis, OR

Bachelor N' Bachelorettes-Dec 23-7:30PM
Abernathy Grange, Oregon City, OR

PLUS

Happy Hoppers– Dec 31
NEW YEARS EVE DANCE
Front Porch Trio
Clark Co S D Center, Vancouver, WA



For Info Call 971-223-6128
Email @ Cabercrombie1@comcast.net
<http://craigabercrombie.webs.com/>



THE GAVEL
Gene & Tanya Currier
 360.427.3261
 curriertanya@juno.com

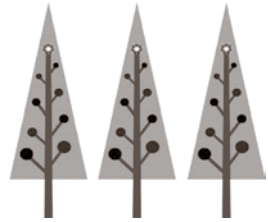

Tall Timber Calling
2016 State Festival
June 17 & 18, 2015
Longview, Washington

Happy Holidays from Gene and Tanya. I know you all will have many fun dances and parties to choose from, so get out there and have some fun. Also, since this is the season of giving, please give to the charity of your choice and help those in need. We will be coming to visit many dances in different Councils so we hope to see many of you in the coming months.

Don't forget that we need to decide what to do about Footnotes in the future. So make sure your council representative gets your and your club's advice prior to the January State Meeting, January 16, 2016. There is a motion on the table to end hard copy publication in June 2016 and go to on-line only starting in September 2016. Remember it was proposed to have FOOTNOTES included as part of the State Federation membership, but the motion was rejected.

This is the time of the year when angels are needed at the new classes, so make it a point to help out when you can. We wish you all a Merry Christmas and a Wonderful New Year. See you on the dance floor.

Gene & Tanya Currier

*"Each Square Dance Lights Anew
 The Flame of Friendship True.
 The Joy We've Had in Knowing You
 Will Last Our Whole Life Through."*

CHARLIE COOK,
CENTRAL AREA COUNCIL



We Remember

Jim Spence, Quincy, WA, January 23, 1941 - November 5, 2015.

Those who knew him will never forget his impish grin, impeccable dress and precise round dance cues. Although born in Arizona, Jim was a true Washington product. He attended high school in Quincy and college in Ellensburg and Spokane. He married his high school sweetheart, Vonnie. They were married 53 years. Last summer Jim and Vonnie became the 17th recipients of the McNutt Award.

A few days ago Vonnie sent the following message:

"Hi My Wonderful Square Dance Family:

I got home around noon on Friday (Nov. 9th) after spending 20 days with Jim in ICU at the Kootenai Health Hospital. The end result is not what I wanted but God wanted him more. I can't thank you enough for the love and prayers you showed for Jim, myself and family during this heart breaking loss."

Jim's funeral was Friday - Nov. 13th at 11:00 at St. Pius X Catholic Church in Quincy Washington. The reception after the funeral was at the Moose in Quincy.

**Hugs,
 Vonnie"**

We Remember

Sterling McKenzie, Cashmere, WA, April 19, 1925 - October 14, 2015.

Former Federation President, Sterling McKenzie, joined the square in the sky in October. A lifelong resident of Cashmere, he married his high school sweetheart, Mary in 1945. They made their home in Cashmere their entire lives. Mary passed away in 2009.

In addition to being Federation president, Sterling and Mary chaired two state festivals and founded the Buds and Blossoms square dance club of Wenatchee.

Sterling was an active caller and teacher who also delighted in sharing his love of dance with others. He was also a well known wood craftsman whose many projects have been enjoyed by us all. His sense of humor, generosity and willingness to help with projects will be remembered.



FROM THE EDITOR'S DESK

Margaret Miller
509-525-9079
m2p2w2@yahoo.com



FROM THE EDITOR'S DESK

Scotty & Shirley Marriner
509-952-3694
ssmarriner2@msn.com



Maggie's Musings

There has been some sad news reported on the passing of some of our older retired Square Dance Leaders. It touches many of our hearts deeply. I know I was not ready to hear nor did I expect some of what I heard... but the cycle of life goes on and if we are lucky we find love even in our later years in the most unexpected places.

As we move into the month of December it is time to count our blessings and hug our family and friends a little longer and tighter. No matter our age or circumstance we all need the warmth of human touch and the smile of a passing of stranger.

I will be thinking of all of my square dance family members and friends and those less fortunate than us.

Yellow Rocks,
Maggie



Ed. Note: During the summer we met up with Maggie in Walla Walla. Even got to help a little bit to move her to her new apartment. A few days ago she sent me the following email: "We finally got the phone mess straightened out. I can't have my old phone number moved to my new address. Here is the new info for FOOTNOTES and all others I know and love. Feel free to share this info." Happy to do so, M. Hugs, Scotty--

Margaret Miller
1701 Plaza Way
Apt 39
Walla Walla, WA 99362-4367
(509) 525-9079

Benefits, Ends & Ideas

What to write about in this space is a perpetual challenge. We want to say something that is meaningful, informational and positive. Jerry Junck, during his Sunday morning address to those of us who attended this year's Leadership Seminar, seemed to us to be the epitome of positive thought. For approximately an hour Jerry reminded us of all the good and beneficial and wonderful things that are attributed to our square dance activity. When you get an opportunity to read his text, do take advantage of his thought provoking ideas. Find out how lucky we are to be square dancers!

It seems that there have been so many losses of our numbers in the past few months. There are, in this issue and have been in recent issues, references to those who have left us. Recently two well-known members have been called home, Sterling McKenzie and Jim Spence. We invite you to remember them as we did on page 5.

It is always hard to write about a loss, and this next one is no exception. Even though a motion was brought to the floor during the September State Meeting, and subsequently not acted upon, to cease the printed version of FOOTNOTES as of the end of this fiscal year, the end is a forgone conclusion. Owing to the diminishing number of subscribers (down to approximately 440 for this issue), coupled with the ever increasing cost of printing and mailing, and the fact that we cannot raise advertising rates for a publication that is continually downsizing its press run, the money just isn't there to keep going. If FOOTNOTES continues in the fall, it WILL be online. Any vote to the contrary is meaningless without the financial means to support it. The Federation did approve subsidizing us until June as necessary, which is appreciated.

That, having been said, opens an opportunity for the entire Federation. There are six issue left. Think about it. They will be historical! The last six issues of a publication with a 66 year history. Want something special? Get everyone in your club, who is not already a subscriber, to order FOOTNOTES for the last six months. Send in a check for \$9.00 (\$1.50 per month) to receive these last six issues. Pass the word. Make the last six months of FOOTNOTES a real gangbuster. Let's see how many partial subscriptions we can muster. We'll try to make them as interesting as possible, and will continue to accept your ideas for articles during the next few months.

Thanks for your support.
Scotty & Shirley

SQUARE & FOLK DANCE FEDERATION OF WASHINGTON

www.squaredance-wa.org

January 2016 State Meeting

Hosted by the

Sou'Wester Council

www.sqdance.org

Saturday Meeting, January 16, 2016 at Rose Valley Grange

State Federation Meeting 9:00 AM - 12 Noon
 Luncheon 12 Noon - 1:00 PM
 State Federation Meeting 1:00 PM - 4:00 PM

Friday Dance Jan. 15, 2016

Rose Valley Grange*

From: 7:30 – 10:00 PM

MS/w Plus Tips, Trail-In, Casual Attire

7:30 Pre-rounds, 8-10 PM Dance

Hosted by Sou'Wester Council

Open Mic

Caller Host: Jim Hatrick

Cuer Host: Lonnie Sycks

Fri. & Sat. Ways & Means to benefit Festival 2016 - Hosted by Sou'Wester Council

DANCE DONATION ADULTS \$7.00 YOUTH \$3.50

***Rose Valley Grange 1520 Rose Valley Rd. Kelso, WA 98626**

Dry Camping by Donation at Rose Valley Grange

Dick & Sandy Sims 360-636-1993 or 360-749-3963

dandssims@comcast.net for details

***Catlin Grange 205 Shawnee St. Kelso, WA 98626**

Saturday Dance Jan. 16, 2016

Catlin Grange*

From: 7:30 – 10:00 PM

MS/ Traditional Attire

7:30 Pre-Rounds, 8-10 PM Dance

Hosted by Ruff & Ruffles

Caller: Jim Raupp

Cuer: Susan Healea

Motels

***Motel 6** 360-425-3229 / Coffee Only
 106 Minor Rd.
 Kelso, WA 98626
 1 Queen \$44.39 2 Full \$51.05
 Reservations 800-466-8356

***Super 8** 360-423-8880 / Breakfast
 250 Kelso Drive
 Kelso, WA 98626
 1 Queen \$63.90 2 Queens \$72.90

***Comfort Inn** 360-425-4600 / Breakfast
 440 Three Rivers Drive
 Kelso, WA 98626
 2 Queens \$89.00 1 King \$99.00

***Guest House Inn** 360-414-5953 / Breakfast
 501 Three Rivers Drive
 Kelso, WA 98626
 1 King \$94.30 2 Queens \$99.85

All Motels are off Exit 39 on I-5 N & S

Meetings

***Leadership Seminar Dinner Meeting**
 5 PM Friday, January 15
 Izzy's / 360-578-1626
 1001 Grant St. 3 Rivers Mall
 Kelso, WA 98626

***XP Breakfast Meeting**
 7 AM Saturday, January 16
 Bob Paul's Restaurant / 360 636 6181
 1140 15th Ave
 Longview, WA 98632

***State Festival Meeting**
 7:30 AM Saturday, January 16
 1520 Rose Valley Rd. [Grange]
 Kelso, WA 98626

***Suggestion for Dinner**
 Kim Bowl Restaurant [Chinese] / 360-636-3388
 1228 Vandercook Way
 Longview, WA 98632

**Rose Valley Grange is off Exit 39 on I-5 S
 or Exit 36A on I-5 N**

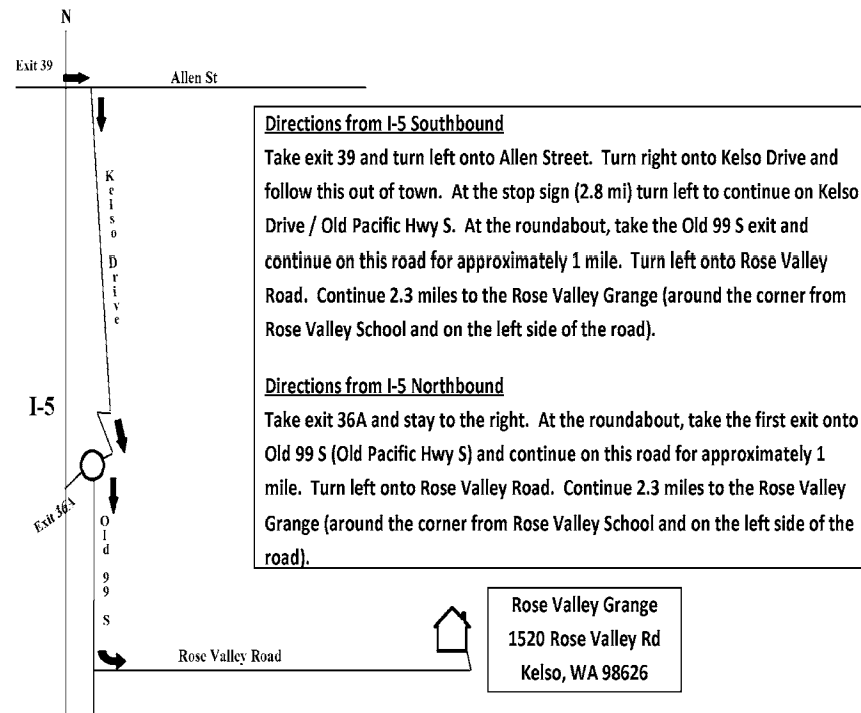

Membership & Insurance

Richard & Barbara Snyder
5612 S. Napa Street
Spokane, WA 99223-8248
509-443-0126
richlsnyder@comcast.net



Who's covered and how do I know

We would like to address a couple of questions we have had recently.

First, when is a Washington square dancer covered by our insurance? A Washington square dancer who is a member in good standing of a Washington federated club, is covered by our state accident insurance when attending a Washington federated club activity (dance, fund-raiser, parade, meeting, etc) and during travel to and from such activity. We also have a liability policy to protect us.

Second, since we no longer receive 'membership cards,' how do we know if we are a member and have insurance? Your club should have you recorded as a member, check with them. As M&I chairmen, we keep a database of the entire federation membership as submitted to us by the federated clubs. Feel free to contact us any time as that is what we are here for. As for insurance, on the state web site, under the M&I tab, there is a generic 'Certificate of Insurance' to verify our policy. Once again, if you have concerns, feel free to contact us.

Another helpful source is on the state web site under the M&I tab a series of questions and answers that may be able to answer your questions. If you have a question that is not on there, let us know, and we will add it.

The three wise men arrive to visit the child lying in the manger. One of the wise men was exceptionally tall and bumped his head on the low doorway as he entered the stable. "Jesus Christ!" he shouted. Joseph said "Write that down Mary, it's better than Clyde".

We wish you and yours a very merry Christmas, and a fantastic 2016!

Take care,
Richard and Barbara

Dancers, Callers, Cuers, Clubs
Please visit and use the Washington
Federation Web Site often

<http://www.squaredance-wa.org>

Send lesson information
immediately to:
Webmaster, Teresa Snider
webmaster@squaredance-wa.org

FOOTNOTES DEADLINE(S)

First of the month preceeding publication
for all articles, ads and photos.

Come and Dance with our Clubs

www.squaredancespokane.org



Coeurly Q's 1 st Saturday 7:00 P; 8:00 MS & R. Harding Family Center, 411 N 15 th St, CDA, ID	Roundup Workshop Tuesdays 7:30 R III-VI. WDC
Dancing Shadows 3 rd Friday 7:00 P & Int R; 8:00 MS & R. WDC	Shirts n' Skirts 3 rd Friday. Calvary Lutheran Church, ID
Diamond Squares 2 nd Saturday 7:00 "MS w/a Twist"; 8:00 MS & R; Plus tip after break. WDC	Spokane Area Council 5 th Saturday 7:00 P & R; 8:00 MS & R Sept – May. NSDC or WDC
Heartbeats Wednesdays except 5 th Beg/Int/Adv Clogging 8:30am. Knechtel's Shop, 211 E Ziegler Ln, Colbert	Spokane Callers & Cuers 2 nd Friday 8:00 MS. WDC
Hi-Flyers 3 rd Friday 7:00 P & R; 8:00 MS & R. Cheney City Hall	Spokane Carousels 1 st & 3 rd Saturday 7:30 R III-VI. East Spokane Grange
Hoodoo Valley Hoedowners , 3 rd Saturday, 7:00 R III; 7:30 P; 8:00 MS & R II. Jewel Lake Barn, Sagle. Special dances during year.	Spurs & Skirts 4 th Friday 7:30 R; 8:00 MS & R. NSDC
Jacks & Jennys 3 rd Saturday 7:00 P & R III; 8:00 MS & R. NSDC	Star Shooters 4 th Saturday 7:00 R III-IV; 7:30 R II; 8:00 MS & 3 rd tip P & R. WDC
Krazy 8's 1 st Friday 7:00 P & R III; 8:00 MS & R. WDC	Twin City Twirlers 1 st & 3 rd Saturday 7:30 R; 8:00 MS & R. Twin City Square Dance Center
Model T's 2 nd Saturday 7:00 P & Int R; 8:00 MS & R. NSDC	Valley Crosstrailers 3 rd Saturday 7:00 P & R; 8:00 MS & R. WDC
North Spokane Dance Assoc 1 st Friday 'Adventures in Dancing' 8:00. 5 th Friday 7 P, 8 MS. NSDC	Wag Arounds 1 st Sunday 7:00 R II-III. WDC. 2 nd Friday 8:00 R III-V. NSDC
Octo-Plus Squares Tuesdays 7:00 P (workshop). East Spokane Grange	Western Dance Association 5 th Friday 7:00 P & R; 8:00 MS & R. WDC
Plus & Stuff Mondays 6:30 Adv; 8:00 Plus. 4 th Friday 7:00. NSDC	Wild Rose Ramblers 1 st Sat. 7 P&R III; 8:00 MS&R. NSDC
For more information contact Richard Snyder @ 509.443.0126	

48TH ANNUAL EDUCATION & LEADERSHIP SEMINAR

Barbara & Mickey Franz

9608 60th St. NE, Lake Stevens, WA 98258-4010
Mickey 425.334.5184 - Barbara 206.719.7293 • wef1938@yahoo.com

Think Summer - Think Seminar

Are you registered yet for the 48th Leadership Seminar? What's that you say? You're not a leader. The Leadership Seminar is for everyone! This is a fun weekend with golf (?) dancing and seminars learning about different aspects of this activity called Square Dancing and FUN.

Square & Folk Dance Federation of Washington

2nd Weekend in July
Friday • Saturday • Sunday



The Seminar is held at beautiful Circle 8 Ranch, located off Eastbound I90 at exit 74. Go south on West Nelson Siding Road turn right onto Lund Lane and follow to Circle 8. The campgrounds has many (70+) grassy RV and tent sites each with water and electricity and some full hook-up. There is an RV dump on site. Cle Elum is nearby (12miles) with several motels. See registration form for directions.

The dance hall has a nice wood floor, plenty of seating, a raised stage and hopefully air conditioned (fund raising was in progress last I heard) if not plenty of fans to circulate the air.

Registration checks should be sent to:

Glen and Tami Shaw
1278 Roy Pl
Camano Island, WA, 98282-6373
360-387-5055

Questions about camping or RV sites should be addressed to:

Wagon Master
Madalyn and Lewis Cato
4444 S 168th ST
Sea Tac, WA, 98188
206-244-4746

All this information and more is on registration form and in Footnotes

Be sure to indicate on registration form whether or not you would like lunch on Saturday.

Mickey and Barb

Square & Folk Dance Federation of Washington

2nd Weekend in July
Friday • Saturday • Sunday



48th Annual Square Dance Education & Leadership Seminar

Circle 8 Ranch, Cle Elum, WA
July 8, 9 & 10, 2016

INFORMATION & REGISTRATION
Glen & Tami Shaw
1278 Roy Place
Camano Island, WA 98282-6373
360.387.5055 • tamisperry@msn.com

Council _____		Club _____	
Last Name _____		First Name _____	
Last Name _____		First Name _____	
Street Address _____	City _____	State _____	Zip _____
Phone with area code _____		Email Address _____	

Do you want the Seminar Booklet?

The booklet, in any form, is included in the registration fee

Yes Via Email
 Paper Copy
 CD ROM Disk
 No - I do not want the book.

Fees: \$15.00 Per Person • \$30.00 Per Couple/Family \$ _____

Camping \$22.00 Per Night (Tents Welcome)

Number of Nights _____ @ \$22.00 Per Night \$ _____

Type of RV (Motorhome, 5th Wheel, Trailer) Circle one

Length of RV _____ Number of slides _____

Desired Space Number _____ Tow Vehicle _____

Arrival Day/Date _____ TOTAL \$ _____

Do you plan on having lunch at Leadership Seminar on Saturday?
Yes _____ No _____

Please make checks payable to 48th Leadership Seminar
Cancellations must be in writing and requested by June 15, 2016
No refunds after June 15, 2016 • NO ROLL OVERS
Full Registration form on State website: www.squaredance-wa.org

YOUTH COORDINATOR

**Tiffany & Matthew
Richard**

Youth Coordinators
teencoordinator2015@gmail.com



Applications wanted for Youth Scholarship

Have you thought about the youth scholarship lately? I have. \$750 to two people who are going to college (mom's and dad's jump on this) and all you have to do is send me your application. It is never too soon to send it to me. Applications are due by April 1st and can be sent my email or mail. Please apply, you don't know how much it really helps until you receive it.

Has your club thought about caravanning to another club yet? I have already gotten calls asking about youth club dances from some adult clubs. What is your club doing to bridge the gap?

Tiffany & Matthew Richard

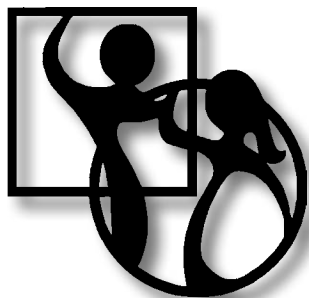

TIGER MOUNTAIN



Engraving and Promotions

Rod & Taj Alex
206-271-5639
rod@tmengraving.com

SQUARELY SPEAKING

Rob & Vicki Krum

Spokane Valley, WA
509.768.7777
robvickik@gmail.com

A WEE BIT OF HISTORY

Hope everyone had a great Thanksgiving. We did with our family all here in Spokane.

We are Rob and Vicki Krum from the Spokane Area Council. We started dancing in 1971 with Fun an Fancy until 1983 when club folded and our two children, who were 11 & 13, needed a taxi for/to all their activities, so we volunteered as all good parents would do.

We got back to dancing in 1988 and have been at it ever since. I started calling in 1991 and I'm still at it. Called for the Valley Crosstrailers from 1994 to 2006, Wild Rose Ramblers from 1998 to present and the Columbia River Squares in Radium Hot Springs B. C. from 1996 to the present. Circle and Swing of Sandpoint ID 1998 to 2004.

I am always looking for topics to write about or comment on, so you are welcome to send ideas to: robvickik@gmail.com

Lessons are down to very small numbers and so are some of the dances as we already know. Think about all the good stuff like friends and just the dancing and if I trade places in the square with someone will the caller really notice and put me back when I am the only one out? Just a thought so get out there and dance,

enjoy the great activity we have and don't worry about the other stuff.

RELAX, HAVE FUN!

SEE YA ON THE FLOOR!

Rob & Vicki



FOOTNOTES DEADLINE(S)
First of the month preceeding publication
for all articles, ads and photos.

ROUND OUT YOUR LIFE

Joyce Sebree

360.427.7165

icueRD4u@aol.com



Stylish dancing is comfortable dancing

I want to write about “Styling”. I have had couples ask me how they can dance better out on the floor. They know the steps but they would like to look smoother. When a couple looks elegant on the floor it is attributed to styling. Many dancers would like to know how and where they can learn styling.

Styling tends to be something that is individually all your own. A round dance teacher starts the process by teaching good technique but you, the dancer, must find the styling within yourself, as that is what distinguishes you from every other couple on the floor. Basic elements of good technique, that when achieved, are the building blocks of that more elegant look.

Posture ranks very high in importance for a good technique. If you want to make an improvement in your appearance on the dance floor, make sure you’re using good posture. Do not slouch or look at your feet while dancing. This tends to look bad as well as uncomfortable. Try working with another couple and demonstrate for each other how you look when you slouch or when you are looking at your feet. Then repeat the same steps using good posture, i.e., head up, shoulders back, stomach and rear tucked in, and knees slightly relaxed. Not only will you look better but the steps become easier to execute.

Another important technique is

correct positioning. In closed-position you should be off-set. This will give each person their own dancing space so they are not stepping on each other. This makes for a much smoother looking couple. In closed position the lady should always keep her head left, this will allow the dancers to achieve certain moves correctly, i.e. pivot. Also closed-position and semi-closed if, done correctly, are barely distinguishable except for head positioning. Eye to eye contact, when dancing, may cause you to lose your personal dance space. This is when you may begin to step on each other.

A firm upper body frame and maintaining your frame, while moving, helps with appearance and is vital for leading correctly. Keep in mind that a proper body frame will always make it easier to execute dance figures.

Always start and end each dance with poise and confidence, you want this to be the final impression you give to the other dancers. And finally, never forget a smile is one of your most important styling assets.

This was information given in a prior FOOTNOTES article and I thought it was important to review cuers Terri & Allan McClelland’s views on styling. The main thing is that we want you to have fun and enjoy Round Dancing.

Have a great month. See you on the dance floor.

Old Time Christmas

CHOREO: Sharon & Tim Pilachowski,

MUSIC: CD “An Old Time Christmas” (Randy Travis);

mp3 download available from Amazon.com- mp3.walmart.com

SEQUENCE: INTRO—A—B—Bridge—A—B—C—B—C—END

PH II + 1 [Hover]

INTRO

**WAIT 2 MEAS IN OPEN FACING PARTNER/WALL; ;
APART, POINT; TOG BFLY, TCH;**

PART A

**WALTZ AWAY & TOG; ; SOLO TURNS; ;
BALANCE L & R; ; VINE 3; THRU, FACE CLOSE;
WALTZ AWAY & TOG; ; SOLO TURNS; ;
BALANCE L & R; ; VINE 3; THRU, FACE CLOSE;**

PART B

**L TRNG BOX; ; ;
HOVER; MANUV, SD CL; 2 R TURNS CP LOD; ;
FWD WALTZ TWICE; ; 2 L TURNS; ;
BOX; ; DIP BACK, HOLD; REC BFLY, TCH;**

BRIDGE

BALANCE L & R; ;

PART A

**WALTZ AWAY & TOG; ; SOLO TURNS; ;
BALANCE L & R; ; VINE 3; THRU, FACE CLOSE;
WALTZ AWAY & TOG; ; SOLO TURNS; ;
BALANCE L & R; ; VINE 3; THRU, FACE CLOSE;**

PART B

**L TRNG BOX; ; ;
HOVER; MANUV, SD CL; 2 R TURNS CP LOD; ;
FWD WALTZ TWICE; ; 2 L TURNS; ;
BOX; ; DIP BACK, HOLD; REC BFLY, TCH;**

PART C

**BALANCE L & R; ; TWIRL VINE 3; PICKUP, SD, CL SCAR DLW;
3 PROG TWINKLES; ; ; FWD, FACE, CL;**

PART B

**L TRNG BOX; ; ;
HOVER; MANUV, SD CL; 2 R TURNS CP LOD; ;
FWD WALTZ TWICE; ; 2 L TURNS; ;
BOX; ; DIP BACK, HOLD; REC BFLY, TCH;**

PART C

**BALANCE L & R; ; TWIRL VINE 3; PICKUP, SD, CL SCAR DLW;
3 PROG TWINKLES; ; ; FWD, FACE, CL;**

ENDING

TWIRL VINE 3; THRU, FC, CL; APART, POINT;



SEW TOGETHER

Karen & Dave Reichardt
dkreichardt@gmail.com
www.squaredancesewing.com

Pettipants Shoe Tote

This is a quick project that can be made from almost any fabric. Make one for every pair of shoes. Make them for Christmas gifts or door prizes. Decorate with lace or ribbons.

Materials

1. Pattern paper 16 x 16 inches
2. Fabric to cut two of pattern
3. As much lace as you want
4. 2 pieces of cord 26" long for the pulls
5. 2 short pieces of cord



Instructions

1. Make the pattern following the diagram and cut two of fabric.
2. Sew lace across the leg area on the right side, starting two inches above the bottom edge.
3. Place the pieces right sides together and sew a half inch seam down the sides like the stitching line in the diagram.
4. Fold the tote in half with the seams on top of each other making legs. Sew the leg seams.
5. **Press** both top seams open. Tuck 2 inch long strips of fuse webbing under the seam allowances at the top edge and press. This keeps the seam allowances flat when the ties are inserted and reinforces the openings.
6. **Fold** the top (waist) of the pettipants over one inch, toward the inside, and stitch all the way around $\frac{3}{4}$ inch from the fold to make a tunnel for the ties.
7. **Make** bar tacks over the seam line at the top edge and stitching line of the tunnel on both the front and back seams. With your seam ripper pick open the seam between the bar tacks on the right side (outside) of the tote.
8. **Insert** one of the long ties in the front opening and work it all the way around until it comes out the same opening. Tie the ends together. Repeat with the back seam. When you pull the ties they will work against each other to shut

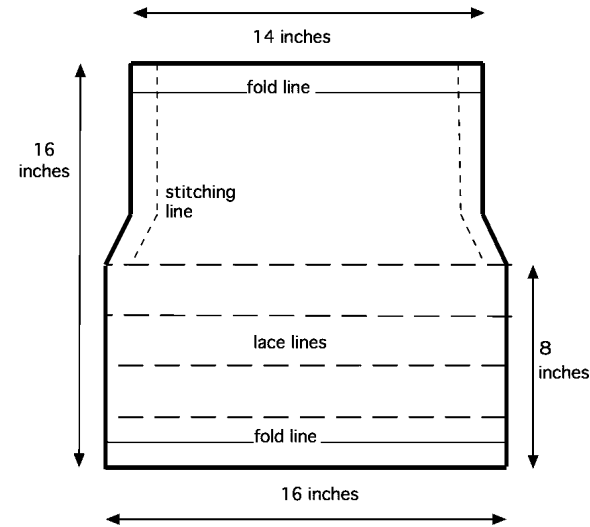

the tote.

9. **Make** a one half inch wide tunnel around the bottom of the legs. Insert some cord and pull it tight. Tie a knot and work the knot inside the tunnel.

Now that you have the basic idea, you can vary the pattern to suit yourself. Even people who don't dance like these shoe totes. They are a great way to pack shoes for travel.

THE CLUBS OF PENINSULA AREA COUNCIL - 6800 W. Belfair Valley Rd, Bremerton KITSAP SQUARE DANCE CENTER IN GORST -- kitsapsquaredance.com

DUDES AND DOLLS
Mondays from 2nd Mon in Sept to 2nd Mon in June
Plus Dancing - 1 - 3 PM
Kitsap Square Dance Center - Gorst
Caller: Don Smith filling in for Willie Sewell
More Info call: Russ Richardson 360-373-1822

SQUARE STEPPERS
2nd Sat. each Month
PLUS 7:30 - 10:00 PM
KSDC, GORST, WA
GUEST CALLERS
Caravans/Mystery Trips/Camping
For info. Call: (360) 377-9494

GIG HARBOR TWIRLERS
7:30 - 8:00 Plus - 8:00 to 10:15 PM MS
1st Saturday of each month, except
1st & 3rd Saturdays in Jan & 3rd Sat in Sep
Lessons, Student Level Dance, MS, Rounds
Come and Dance with us in Gorst, WA
360-692-3723
Caller Roger Spiese & Cuers Carolyn & Larry Small

KITSAP SQUARE DANCE CENTER
GORST (BREMERTON)
RV CAMPING \$15.00 PER NIGHT
FOR SQUARE DANCERS
WATER & ELECTRICITY AVAILABLE
Come Dance With the Gig Harbor Twirlers,
Paws & Taws, Dudes & Dolls Plus,
Round Squares & Square Steppers Plus

ROUND SQUARES
4TH Sat. 7:30 - 8:00 Plus - 8:00 - 10:00 PM MS
3rd Sat. Dec. only
KSDC, GORST, WA.
GUEST CALLERS
CUER: JOYCE SEBREE
Caravans, Mystery Trips - Camping \$15 per Night
Info call: 360-307-8460

PAWS AND TAWS
7:30 - 10:00 PM Mainstream, Rounds, Plus Tip
1st & 3rd Fri Sep - Jun except Mar 1st Fri & 3rd Sat
3rd Saturday only in July & August
CALLER: Roger Spiese - CUER: Shawn Cavness
Kitsap Square Dance Center, Gorst
Caravans-Mystery Trips-All Dancers Welcome
Info: 360-930-5277

THE SOLO CORNER

Kathy Rooney

dancerooney@centurylink.net
360.456.8031



HISTORY, HELPING AND FOUNDING OF LOLO

1970's...Missoula, Montana. Fran Price, a Missoula square dancer lost her husband and partner. Fellow dancers Ray and Afton Granger were saddened to see their friend turned away from dancing...the joy of her life.

Around this time word circulated that solo dancers in Seattle had formed their own clubs. Excited to learn this, Fran, Ray and Afton traveled to Seattle to scope them out. Ray and Afton were so enthusiastic to be part of this new solo movement they sold their home to finance a square dance center, which exists even today as the Lolo Dance Center.

The two Seattle clubs were the Solo Squares and Single Stars. The Missoula dancers named their club Solo Stars, jokingly calling it the child of the two Seattle clubs. Launched in the mid-70s, the club is still active at the Lolo Dance Center. Though the Grangers are gone, their daughter and son-in-law, Bobbie and Barry Bartlett still operate the Dance Center. Lucy Mikelson, now Lucy Prindle, was one of those grateful solo dancers who was thrilled to have Solo Stars spring up in Missoula.

In early 1990 Lucy left Missoula for Seattle, escaping employment conflicts that left her traumatized and seeking a fresh start. She moved to Burien to be near the Promenade Center. Also, in the area was Hagen's Barn (now Rocking Horse Barn). Though she credits square dancing with saving her life, because, as Lucy says, "We can't cry over the past when we're dancing", there were some rough patches.

One night she attended the S.T.P.'s dance at Hagen's Barn. Lucy walked in wearing her Solo Stars badge and the woman at the front desk told her, "Listen here, maybe you can dance at a couples club in Montana by yourself, but here you have to bring a partner." (Hard to believe the square dance logo is FRIENDSHIP SET TO MUSIC!) Fortunately Lucy discovered Singles on Saturday, a traveling club.

Singles on Saturday was formed in Portland, Oregon in the mid-eighties by solo dancers craving a Plus venue. They would attend couples clubs wearing their red and black club colors, but there were rules. They had to dance with their own group, not with married couples. They used a rotation board, changing partners each tip. Unfortunately, when there were more women than men, women had to sit out some tips. The group was quite successful and, eventually, a club formed in Seattle.

The gender gap in square dancing is another complication of solo dancing, to be discussed later.

Sou'Wester Council has contracted with callers and cuers you are sure to enjoy! For many of you, these may be familiar names, but to those to whom they are new, we introduce Chuck & Sandi Weiss.



Square and round dance enthusiasts for 36 years and teachers for 30, Chuck and Sandi offer dance instruction through Phase VI. They have choreographed many dances, several of which have been selected as rounds of the month in various states and Round of the Quarter for ROUNDALAB. They have also cued and taught at twenty-two National Conventions. Most recently, they have been featured leaders at the annual Indio RivCo Square and Round Dance Festival, the Midwinter Festival, and Mid-Summer Roundup, the latter two which are in Oregon.



*Featured cuers
Chuck & Sandi Weiss
Mesa, Arizona*

In October of the last eight years, they have participated in the St George, Utah Huntsman World Senior Games in the medal activity of Square Dancing. Each of the eight years they have won medals and now hold silver, bronze or gold medals in each category; Mainstream, Plus and Advanced. Chuck and Sandi have amazing depth of expertise. You are sure to enjoy dancing to Chuck and Sandi's cueing!

**Tall Timber Calling
2016 State Festival
June 17 & 18, 2015**

**Cowlitz Regional Conference Center
Longview, Washington**



BLUE MOUNTAIN COUNCIL

Margaret Miller
Area Reporter
509-522-2716
m2p2w2@yahoo.com



Greetings from **COLUMBIS RIVER SQUARES**. Here it is Halloween and the December FOOTNOTES article is due and we haven't had a November dance as of yet. CRS is sure everyone will have enjoyed the November 14th dance with Steve Noseck and Bill Holm and dancing with Doug Davis and Bill Holm on November 28th (it was good way to have worked off our Thanksgiving dinner).

December 12th will be a beginner level dance with Rob Krum calling and Bill Holm cueing. This is the annual toy drive for Christmas Angels for Kids so please bring a toy to brighten some child's Christmas.

December 31st is the annual Circle of Friends New Year Eve Dance with Daron Tandberg calling and Bill Holm cueing at the Shanty. Prairie Shuffles will be hosting this festive event.

MERRY CHRISTMAS AND HAPPY NEW YEAR TO ALL!

Karen Holm

The **MILTON-FREEWATER MUDDY FROGS** are having fun with their mainstream class with Bill Reid calling and with a good group in the jive/swing social ballroom class taught by Neva Reid.

December will bring our Christmas dance Sunday afternoon, December 20th, from 3:00-5:00 at the Community Building in Milton-Freewater called by Bill and cued by Neva. There will be a turkey dinner immediately afterwards. The turkey will be furnished, so bring something good to go along with it.

December 31st will find us once again getting together with the Walla Walla Family-a-Fair club for a bang-up New Year's Eve party, this time ending with breakfast cooked at the hall! This is always a very special evening. We hope to see you there!

Keep on dancin'!

Barbara Walter

FAMILY-a-FAIR: We are having our lessons and the new dancers are doing great. We welcome the cooler days. Our holidays are coming soon. We are planning our Christmas parties and look forward to seeing you across a square. Have a great Holiday.

Mickie Thompson, Club Reporter

PRAIRIE SHUFFLERS snow birds have flown south for the winter. What fun they are going to miss in the Tri Cities. We have a good group of people taking lessons this fall -- with three plus squares on Mondays and Thursdays evenings. We are planning on a potluck dinner dance Friday December 18th (see our ad for more info) inviting our class. This was a lot of fun last year. We are also planning fun fun time for our New Years Eve Dance; mark it on your schedule. Love, Laugh, and have Fun – life is short. Prayers offered for our square dance family.

Jeanne Cozad

The **MELODY MIXERS** dance every Tuesday evening at the Shanty in Kennewick. Our regular program is Phase 4 dancing 5:30 to 6:30. Beginning Waltz lessons 6:30 to 8:00 and Phase 2, 3 & easy 4 dancing 8:00 to 9:30.

The 3rd Tuesday in December (December 15th) will be our annual Christmas Party Dance night when we dance 7:00 to 9:30 dancing some of everyone's favorites and some Christmas dances. Guest are always welcome. For more information please contact Bill & Karen Holm at (509) 542-1310.

Bill Holm, bkholm@charter.net

MUDDY FROGS SQUARE DANCE CLUB



Caller: Bill Reid
Cuer: Neva Reid
3rd Sundays • 3 to 5 PM

Milton-Freewater Community Center
 105 NE 5th Milton-Freewater, OR
 For info • e-mail: merriannah@charter.net



BLUE MOUNTAIN COUNCIL

Sunday

Muddy Frogs: Mainstream and Rounds
 3rd Sunday Year Around
 Bill & Neva Reed Teachers with Guest Callers/Cuers (see ad)
 Milton-Freewater Community Center 109 NW 5th
 Milton-Freewater, OR
 Contact Merri Anne Huber 541-861-9055 or
 merriannah@charter.net

Tuesday

Melody Mixers: Rounds Ph 2-4
 Every Tuesday Year Around
 Cued by Bill & Karen Holm
 Shuffler's Shanty 717 N Irving, Kennewick, WA
 Contact Karen Holm 509-542-1310 or bkholm@charter.net

Thursday

Tri-City Circulators: Plus and Rounds
 Every Thursday Year Around
 Caller Jim Swanson & Guest Cuers
 Eagles Lodge #2485 115 Fruitland St, Kennewick, WA
 Contact Thelma Swanson 509-539-2660 or
 paintedswan@frontier.com

Friday or Saturday

Prairie Shufflers: Mainstream with Plus and Rounds
 1st & 3rd Friday or Saturday September thru July (check ad for details)
 Guest Callers (see ad) and Cued by Bill Holm
 Shuffler's Shanty 717 N Irving, Kennewick, WA 509-783-4222
 Contact Jeanne Cozad 509-302-7334 or
 jeannecozad@charter.net

Columbia River Squares: Mainstream with Rounds
 2nd & 4th Saturday September thru June
 Guest Callers/Cuers
 Richland Community Center 500 Amon Park Dr Richland, WA
 Contact Vickie Weber 509-546-1435 or
 vickiweber99@yahoo.com

Family a-Fair: Mainstream with Plus and Rounds
 1st & 4th Saturday Year Around
 Caller Jim Swanson/Cued Lorna Hayden
 Elks Lodge 351 E Rose St Walla-Walla WA 509-525-2870
 Contact Thelma Swanson 509-539-2660 or
 paintedswan@frontier.com



**CENTRAL
AREA
COUNCIL** www.centralareacouncil.org
Area Reporter
Carel & Michael Edgerly
509-674-5744
carel@centurylink.net

CENTRAL AREA COUNCIL has enjoyed dancing with our clubs this fall and are looking forward to kicking off the upcoming holidays at the Gateswingers' Anniversary Dance, followed by all the special dances and parties. And we're planning our next 5th Saturday Dance on January 30th at the Fruitvale Grange, 2908 Castlevale Road in Yakima, with Scott Coon and Debbie Taylor, hosted by the Silhouette Dancers.

We join other dancers in our area and around the state in sending our prayers to Vonnie Spence as she and we mourn the loss of Jim.

And our best wishes to everyone for a safe and wonderful Christmas season, and lots of dancing in the coming year.

Carel Edgerly, carel@centurylink.net

BLUE AGATES will dance on Friday night, December 11th, for our regular dance at the Swauk-Teanaway Grange with Daron Tandberg calling and Cyndi Silicki cueing. This dance starts at 7:30 pm. Because of the Christmas holiday, the other regular dance on Saturday, December 26th, is canceled.

Some of our club members plan to caravan to the Gateswingers' Anniversary Dance on Saturday, December 5th, for their afternoon Plus dance, enjoy the roast beef dinner, and the big dance.

Blue Agates join the other clubs in Central Washington in extending our thoughts and prayers to Vonnie Spence.

Sally Gililand, sallygililand@gmail.com

The **GATESWINGERS** are ready for the BIG hunt. That is the 'hunt' for the perfect dance hall Christmas tree. It is always between very big to gigantic! The Big question is: Will we get that BIG tree through the door? Somehow we always manage. Next we get together to make swags from extra boughs for decorations. And of course there is the Big get together for final decorations. You have probably figured out we also have 'food' associated with everything we do. So you can see this is a BIG time for the Gateswingers. We do it all for our Anniversary Dance; so do not miss it.

Let's go to Gateswingers 61st Anniversary and 'Let it Snow' (that is our theme). December 5, 2015 at 7pm to 9:30pm at Yakima Square and Round Dance Center, 207 East Charron Road, Moxee, WA. Caller is Tom Clymer. Jim Dobbs will fill in as the Cuer for Jim Spence. Preliminary events: 2 pm to 4

pm is a Plus Dance. 5:30pm is Bob Hamilton's famous Roast Beef Dinner (\$10/person/ kids reduced. RSVP 509-966-4356). 7pm is Pre- Rounds. 7:30 pm to 9:30pm dance with 'Load the Pot' prize drawings. We end it all with pies.

Other opportunities: December 12th is Saturday student dance. December 19th is Christmas Theme Dance. Note: Round Dance on the 25th is CANCELLED for Christmas. We wish everybody a Merry Christmas.

Jan Logan, ojlogan@charter.net

It seems that we just got started dancing this month and it is already the end. The **SILHOUETTE DANCERS** have been busy with our various lessons and dances. Our new students need to be complimented on their dancing. They are doing great!! Now that summer/fall traveling is over for awhile we have a full crew again. Lots of fun dancing with friends! We welcome guests!

Have a wonderful Christmas holiday and the best New Year.

Dorothy Crosslin



FOOTNOTES
 address
FOOTNOTES
 PO BOX 11160
 YAKIMA, WA 98909-2160

FOOTNOTES DEADLINE(S)
 First of the month preceeding publication
 for all articles, ads and photos.

GATESWINGERS

Sept. thru May: 1st & 3rd Saturdays
 1st Saturday Pre-Plus 7:00 PM
 3rd Saturday Pre-Rounds 7:00 PM
 Mainstream 7:30 - 9:30 PM
 with finger food following the dance
 4th Fridays Phase II Rounds 7:30-9:30 PM

ORVIN LOGAN, Caller
CYNDI SILICKI, Cuer

Summer Dance -- 4th Saturday in July
 caller & cuer to be announced
 Yakima Valley Square Dance Center
 Moxee, WA Info: (509) 949-6712
 Gateswingers@ Circle 8 Ranch
 2nd Weekend In August

BLUE AGATE SQUARES

2nd Friday, 4th Saturday
 7:30 - 10:30 p.m.
Daron Tandberg - Caller
Cyndi Silicki - Cuer
 Swauk-Teanaway Grange, Cle Elum
 Date: 509 260-1025 or 509 674-5275

SILHOUETTE DANCERS

1st Thursday Intermediate
 Thurs - Ph 2 + 7:30-8:30 pmsome intermediate
 Ph3/4 lessons 6:30-7:30 pm Dance/Workshop 8:30-9:30 pm
Cuer: DEBBIE & PAUL TAYLOR
 Fruitvale Grange, 2908 Castlevale Road
 Yakima, WA 98907
 509-965-3015 • Visitors Welcome

Donna & Tom Rohde

AREA REPORTER

253-833-2825

donnalou13@comcast.net

www.cpsc-squaredance.org



In October, the **BOOTS & LACES** caravanned to the Solo Squares in Burien, then traveled North the next Sunday to dance with the Mt. Baker dancers at their Fall Festival. It was a challenge to get there because of the many road closures taking place on that Sunday. Those attending had a good time at the dance, then relaxed having dinner together before going home.

We would like to thank the guests who attend our dances. You make the evenings more fun for all of us. A special "Thank You" to Brett Kappenman, who was the Caller for our "65th" Anniversary Dance on Friday, November 6th. Debbie & Paul Taylor always add an extra special touch to our dances.

Our members wish all our dance family a wonderful Merry Christmas and a Happy New Year. December keeps us busy doing the usual caravans, lessons and dances as well as all the extra activities we do during this busy month. Be sure to think about those less fortunate than ourselves and donate a toy or two to one of the many charities that will be collecting items for someone in need.

Jan Emerson, emersonbobjan2@hotmail.com

JACKS & JILLS are thrilled to have new dancers with us! The holiday season is upon us and it is the perfect time to hone your dance skills and make friends in the square dance community. I remember vividly going to all the dances I could find so I could practice, only to discover new friends in the adult community. Dancing with kids can be extremely fun, but dancing with the adults adds to your manners. I believe firmly that all kids should dance with adults at one point in their lives to see what has gone before and give honor where honor is due. They might not dance as fast or as hard as the "youngin's", but our dancing seniors are a treasure and know how to have fun! Can't wait to interact with you all during this stretch of holiday dances!

Emily Kosterman, daughter.kosterman@comcast.net

Christmas time is coming and ever so close. Don't you just love this time of the year?

The **JETSTEPPERS** have been enjoying the Fall with lots of fun dances. We invite you to join us for both of our dances this month of December. Our first dance is on December 5th which is our "Toy for Tots" Dance. Bring a new and unwrapped toy and that is your ticket to dance with us. Our second dance for

December is on the 19th. It will be our Christmas Dinner and Dance evening!

I ask you all not to forget the "Reason for the Season". Our Dear Lord Jesus' birthday. I wish you all the happiest and most wonderful Christmas!

Sharon Buechler, buechler73@comcast.net

The **PI-R SQUARES** had two great dances in October. Our Harvest Moon Dance was well attended and Andy and Kyle did a great job of keeping us moving and having fun! The second dance was our Halloween Spook-Tacular and had lots of costumes with Linda Reichert winning the best costume contest. Lots of other costumes also deserved to win. The Pi-R's caravanned to the Flutter Wheels dance at Lac-A-Do Hall in Olympia with Steve Noseck calling and Steve is always good!

In December, our first dance on the 12th is a Student level dance called "Holly Jolly" Dance. Come and dance to Andy and Kyle. On December 26th, our dance will be called "Christmas Memories." Come and dance away all the worries and too much of the good stuff from Christmas.

On December 5th, we caravan to the Wagon Wheels with Wayne Easton and that is always a fun evening!

Our classes are going well with Brett Kappenman teaching on the 1st and 3rd Thursdays and Andy Garboden on Saturdays before our dance. Not a real big class, but they are having fun learning our hobby. Have a Happy Christmas and New Year and come and dance with the Pi-R's any 2nd or 4th Saturday at the Meridian Grange.

Terry & Marilyn Quinnett, mvjunkdealer@juno.com

WAGON WHEELS want to wish all the Square and Round Dancers a Blessed and Joyous Christmas Season!

November was a busy month with honoring our Veterans at our Red, White & Blue Patriotic Dance on November 7th and collecting toys for children at our "Toys for Joy" Dance on November 21st. We also enjoyed caravanning to the "Boots & Laces 65th Anniversary Dance" on November 5th and dancing to Brett Kappenman's great square dance calling! Congratulations Boots & Laces on your many years of fun square dancing!

December 5th will be our second annual "You Choose It" Raffle Dance. This is similar to a silent auction, but dancers will buy raffle tickets and place them in a paper bag corresponding to the item or gift certificate that they are hoping to win. We have "Boots & Laces" and the "Pi-R Squares" caravanning to us which should make this a very fun dance!

December 19th will be our Christmas Dance which is always a very festive evening!

Both of our December dances will be Student Level Dances which our students are looking forward to. Students from various clubs are invited to come

EVERGREEN COUNCIL

www.sqdance.com

AREA REPORTER

Colleen Sawyer

360-600-1804

embroiderybycolleen@yahoo.com



HAPPY HOPPERS with 3 scheduled dances, December will be an active month for the Happy Hoppers.

In an effort to provide our Mainstream students with some Happy Hopper floor time, on December 5th, we will have a "Mainstream Splurge" dance. The format for this dance will be Plus tips from 7:00 to 8:00, and Mainstream tips for the rest of the evening from 8:00 to 10:30. Callers will be Jim Hatrick and Darrell Kalmbach; Dorothy Lowder will be cueing.

On December 19th, we will have our annual Christmas dance, with all singing calls. Pre-rounds will start at 7:30, with Plus tips from 8:00 to 10:30. Jim Hatrick will be calling and cueing.

Our annual New Year's Eve dance is themed as "The Wild West". A buffet dinner will be served at 7:30. Plus tips start at 8:30. The Front Porch Trio (Jim Hatrick, Craig Abercrombie, and Adam Christman) will "bring order" to the festivities. At midnight, Jim will offer a toast to the New Year.

For the first 2 dances this month, we are re-visiting our annual Christmas Toy Drive. Please bring unwrapped toys for us to donate as presents for kids in need.

Because the first Saturday in January is so soon after our New Year's Eve Dance, we'll be dark on January 2, 2016.

We work hard to make our education program a comfortable environment for students. Many of our club members volunteer as "Angels" to help make it an easy and productive experience. We encourage beginning dancers to start introductory lessons on the first Monday of every month at 7:30. We are committed to serving both beginners and continuing students with our lesson format. Every Monday, Plus lessons will be given at 6:30, Basic lessons start at 7:30, and Mainstream lessons are available at 9:00.

Marc Kahn

The **SILVER STARS** will be having our annual Christmas dance on December 12th with Chuck Garner calling and Dorothy Lowder cueing. We will be having a holiday baked goodies auction during the dance. Please bring your favorite goodie and share in the fun. Dancing begins with Plus from 7-8 pm and Mainstream from 8-10 at the Hazel Dell Grange. We will also have a dance on December 26th with Darrell Kalmbach calling and Dorothy cueing. Come dance with us and jumpstart that New Year's resolution. In January we begin our

new dance schedule and night. Our schedule changes to dancing on 4th Friday's beginning on January 23rd, 2016 with Darrell Kalmbach as our club caller and Dorothy Lowder our club cuer. Our dance night will begin with Pre-rounds from 7-7:30, Plus from 7:30-8, and Mainstream from 8-10.

We would like to wish you and your families and loved ones a very Merry Christmas and a Happy New Year. Safe travels and yellow rocks to all.

Teresa Hill

Happy holidays from the **BUZZIN' BEES**. We are gearing up for a busy holiday season but it isn't as busy as we anticipated because our lessons didn't get off the ground. We plan to try again in the New Year.

Our first dance in December (12/5) is a theme dance called "Silver Love". We want to show our appreciation for senior citizens and we will be taking donations of items to then be donated to local Assisted Living facilities. We did this last year and it brought tears to my eyes to see the gratitude from the activities directors where we made the donations. Donations can include personal toiletries, socks, slippers, lap blankets, word search books, crossword puzzles, stationary, stamps, and picture puzzles. Please come to join the fun and bring a donation to honor our Seniors.

The second dance in December is our Christmas dance on 12/19. Come and share the holiday cheer.

Yellow rocks from the Bees!

Debbie Broers

Buzzin' Bees MS Square Dance Club

1st & 3rd Sat. at Hazel Dell Grange
Pre-Rounds at 7:30 Squares at 8:00
7509 NE Hazel Dell Ave.
Vancouver, WA 98665

Caller: K.C. Curtis
Cuer: Debbie Combs



Questions? (360) 253-3820



Silver Stars

Square Dance Club

Hazel Dell Grange
Vancouver, Washington

Caller: Chuck Garner, 2nd Sat.
Caller: Darrell Kalmbach, 4th Sat.

Cuer: Dorothy Lowder
7:00 Plus 8:00 Mainstream
Dark July & August

Info: 360.600.1804 & 360.573.0446

Website: www.silverssqdance.org

PRAIRIE SHUFFLERS

Shufflers Shanty

717 N. Irving, Kennewick

FRIDAY OR SATURDAY DANCING:

PLUS 7:00 - 8:00 PM

MAINSTREAM 8 - 10:30 PM

December 4th-DAVE BOGGS/TINA ALLAWAY

December 18th-LARRY CLARK & TINA ALLAWAY/BILL HOLM

December 31st - 9:00 - 12:00

DARON TANDGERG/BILL HOLM

January 15th-TINA ALLAWAY, MC & 4x8 YOUTH CALLERS/
BILL HOLM

509-628-0354 or 509-783-1521



**MOUNT BAKER
COUNCIL**

Leslie Keyes

Area Reporter

l_a_keyes@msn.com

December is the time to reflect back on the year and look forward to the holidays and spending time with family and friends. **MT. BAKER COUNCIL** was saddened to learn of the passing of one of our long-time members, Sharan McCracken, in late October. We extend condolences to her husband, Cliff, and their family. Cliff & Sharan have played a vital part in selflessly promoting square and round dancing across our council and the state. Sharan's gentle nature and always friendly smile and warm greetings will be greatly missed.

Please consider making a toy donation during the Mt. Baker Council Toys for Tots drive. You will make many children very happy with your generosity!

Wishing everyone peace and happiness during this holiday season and throughout the coming year.

Leslie Keyes, L_a_keyes@msn.com

At the Seaside Sashay this year, my corner was Alan (age 87) and his wife, Pat (age 91), dancing as leaders. They were marvelous dancers having danced for 63 years. They were smooth having learned in England coming to this country for more opportunity to square and round dance. If we are going to live longer,



Dancing at the Turn Around on the Promenade in Seaside
Below: Alan & Pat Brokosis, dancers of 63 years.

Photos by Jean Raymond



we might as well make the best of it... start square dancing...yesterday. The Brokosis were such a charming example of why it is good for us.

The Seaside Sashay was a full weekend with dances in the Convention Center, at the Shopping

Mall and on the promenade, weather allowing. This drew crowds of vacationers tapping their feet. They also offered prizes donated by the local business people and a free weekend for next year's dance. The callers, Daryl Clendenin and Chuck Garner were lively as was one of our favorite cuers, Debbie and Paul Taylor. Next year they offer Debbie, Ray Brendzy and Denny Lantz. Plan your next vacation around a square dance. Clam chowder and fish and chips smell good all over town.

HAPPY HOPPERS had their annual Christmas wreath making / soup party social where everyone left feeling proud of their creations; and enjoying their friendships and homemade soups.

So many clubs, Happy Hoppers included, respond so generously to food banks and Toys for Tots. It is a small gift from each of us but it amounts to BIG heartfelt gift to others thanks to you all. On December 5th, Gary Monday and Bob Berka will Jive up the floor (with toys) and our Christmas Ball on the 19th will be charmed by Steve Noseck and Stephanie Speelman. Lots of things to feel good about!



Winthrop is another grand event to take in next year dancing on the street and in the big barn. Crowds are getting bigger every year with good reason...it is lots of fun and the Hoppers got the "Boot" again.



Above: the "BOOT"; 2nd place; Horseshoe, 1st place; Left: Street dancing in Winthrop.

Photos by Jean Raymond

Hoppers plan to visit some of you on the New Year's celebration for we really enjoy someone throwing a big party for us as we will be dark on January 2nd.

I've learned that education, experience and memories are three things that can never be taken away from you (age 67). Keep making them and may this season will bring you some new ones.

Jean Raymond, frjr@msn.com

Ahh, December, beautiful December. The snow is falling, somewhere. The air is crisp, somewhere. The sights, sounds, and celebrations of Christmas are everywhere. The trees are decorated, and the gifts from the stores and the delivery companies are being wrapped, readying for the onslaught of the gift receivers.

On December 4th **DUDES & DOLLS** have an outgoing Caravan to Woodinville Square Crows.

"It's Beginning to Look a Lot Like Christmas" is the D&Ds only dance

this month on December 11th is the last opportunity for you to bring a new unwrapped toy to the hall for distribution to those that are in need at this Special Time. Get involved by donating.

The fourth Friday is Christmas Day. The scheduled dance is pre-empted by a Birthday Celebration.

Have a Merry Christmas, and get ready for a fantastic New Year. The best greetings and blessings are wished for you and yours.

Warren B Funnell, WarnFnel@msn.com

The **FIDALGO FOGCUTTERS PLUS CLUB** hosted a very successful Council Dance for Mount Baker Council with about 300 dancers, including almost 50 new dancers in our No Experience Necessary Hall with Dave Harry teaching. Halloween Hocus Pocus was held at the Stanwood Middle School, a most wonderful venue with two dance floors, and a lot of costumed dancers had

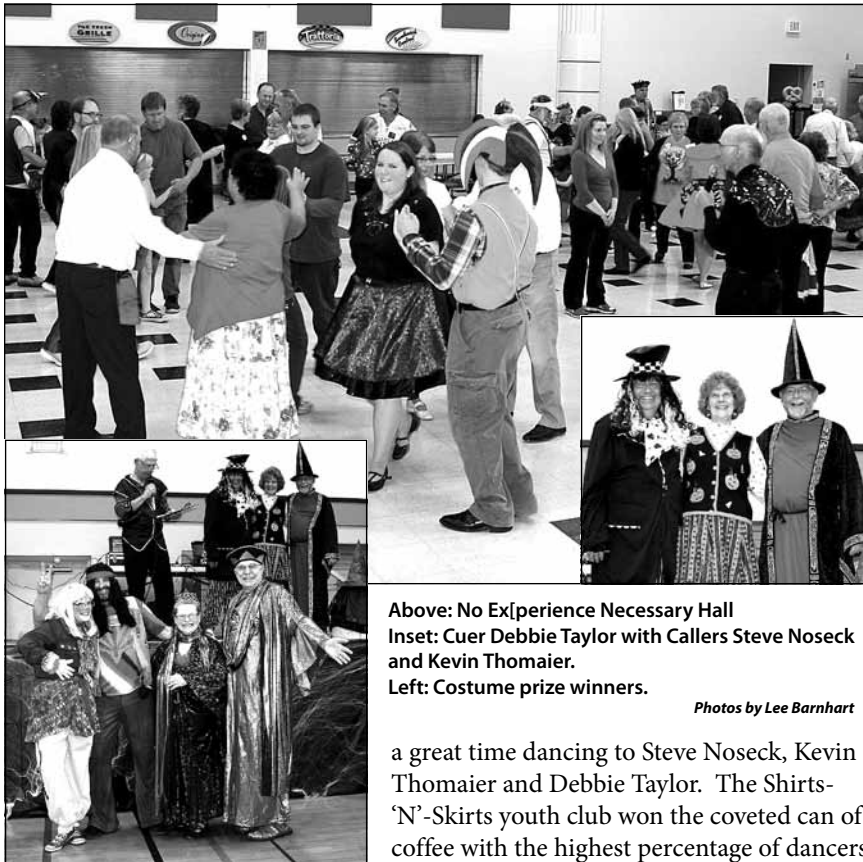

Above: No Ex[perience Necessary Hall
Inset: Cuer Debbie Taylor with Callers Steve Noseck and Kevin Thomaier.
Left: Costume prize winners.

Photos by Lee Barnhart

a great time dancing to Steve Noseck, Kevin Thomaier and Debbie Taylor. The Shirts-‘N’-Skirts youth club won the coveted can of coffee with the highest percentage of dancers present, and they also ran a photo booth as a fund raiser for their club. Many thanks go to the Fogcutter members for all of their hard work to organize and host this dance. As well, we want to thank those

who attended from other Councils and to our Canadian friends from the north who also attended.

At our first Friday dance in December, club members will be bringing food items to support the Skagit Valley Grange’s drive for the Alger Food Bank, as well as bringing Toys for Tots which is an ongoing project for Mount Baker Council. John Corrigan will be calling this dance. John is walking some now with his boot, but still is dependent on his wheel chair for a good part of the time. We are glad to see that he continues to improve. Gary Monday will be calling our third Friday Christmas dance; Bob and Linda Berka will cue both dances. In December the Fogcutters will caravan to the Skagit Squares for their Christmas Dance on the third Saturday.

And finally, we close the year, and welcome in the New Year with a dance sponsored by four north-end clubs of our area at the Skagit Valley Grange. For this dance the Fogcutters share the duties and fun of the evening with the Skagit Squares, Rainbow Squares and Stanwood Sashayers for a mix of Plus and Mainstream and Round Dancing. This year the caller is Kevin Thomaier and the cuers are Bob and Linda Berka. Merry Christmas and Happy New Year to All!

Gailyn Ploeg, ploegrj@msn.com

FREEWHEELERS enjoyed our “Harvest Dance” and collection for Northwest Harvest on November 1st. A great time was had by all with the bonus of contributions of food and monetary donations that give back to our community. Our November 15th Thanksgiving Student Level Dance was called by Dennis “Spyder” Webb and cued by Debbie Taylor.

Special thanks to the Fidalgo Fogcutters for sponsoring the Fall Council Dance “Hocus Pocus”. It was fabulous!!!

We hope to see many of you on December 6th for our “Toys for Tots” Dance. Our guest caller will be Gary Monday with Debbie Taylor cueing. The Whirlybirds and the Sky Valley Whirlwinds will be visiting. We will gather toys and donations for families in need. Our “Happy Holidays” Potluck and Dance on December 20th will begin at 6:00 pm. We enjoy eating almost as much as dancing so please join us for food and fun. Roger Spiese will be calling and Debbie Taylor will entertain us with dances to the music of the holiday season.

Caravanning to other clubs is a great way to promote square dancing. We visited the Skagit Squares in November and we look forward to visiting the Fern Bluff Squares in December.

Freewheelers wish you all a happy and healthy 2016.

Ruth Jester; ruthjester@frontier.com

December 4th **WOODINVILLE SQUARE CROWS** Christmas dance will be called and cued by Craig Abercrombie. We will not have a second dance this month, but in January, we’re changing our schedule to Saturdays once a month. Also January 5th, we’re starting a beginner’s class with Mike Olson teaching. Any dancers who were not able to continue lessons, couldn’t start in September or

need more floor time are welcome to join us!

The Square Crows wish everyone a wonderful Christmas and a Happy and safe New Year. We'll see you on the dance floor January 23rd!

Lynn Von Seggern, lynnv@squarespeed.com

The **CASCADE CROSSFIRES** continue to offer an "Awesome Plus" (all-position) workshop for experienced plus on Mondays. Lessons (Oct-Dec), a workshop, or the 4th Monday "Extravaganza" follow all "Awesome Plus" sessions.

We encourage all plus dancers to join us for our 4th Monday "Extravaganza" (plus dancing; no lessons)—including those who only dance a plus tip at weekend dances. Our Monday: December 21st "Extravaganza" (7-9:00pm) will be a Christmas Party & Plus level dance.

The Crossfires are very busy planning a New Year's Eve Plus dance at the Juanita Community Club.

Check us out at cascadecrossfires.org.

Diana Freyfogle; freyf@comcast.net

Happy Holidays! **RAINBOW SQUARES** had a lot of fun so far this year. Our dances have been colorful and festive, with everyone having a great time dancing to the calling and cueing of our own Brent Mawdsley.

We are delighted to have 5 enthusiastic students in our new dancer class this year being taught by Oren Gaskill. They are looking forward to attending some of the upcoming level dances.

Our Christmas "Kandy Kraze" student level dance is on December 12th, with Brent calling moves 1-40. There will be a "Toys for Tots Drive", and we will have our famous "experienced" clothing sale going for dancers. We will not have a dance on Dec 26th. We wish everyone a happy holiday. See you in the New Year!

Oren & Lew Gaskill, olgaskill@comcast.net

The **SKY VALLEY WHIRLWINDS** will be caravanning to the Freewheelers on December 6th. We will be "Rocking Around the Christmas Tree" at their December 18th dance with Andy Garboden calling and John Neverdowski cueing holiday season dancing. The Skagit Squares will be caravanning in to visit this Christmas dance. By that time our contributions to Toys for Tots will help bring a joyous holiday season for many youngsters. Our Christmas Party and potluck has always been a nicely attended event with delicious food and fun games to play.

Sky Valley will be also be planning for our square dancing lessons that start in January on Thursday, January 7th.

Roy Johnson; royjohnson@comcast.net

It's December! Looking back at November, were you at the **WHIRLYBIRDS**

MOUNT BAKER Continued on Page | 36



www.squaredance.org **Council**
www.squaredance-wa.org **State**
See 2015-2016 State Directory for street addresses of halls.

CASCADE CROSSFIRES Plus Mondays 7:00pm @ Sammamish Valley Grange, Woodinville – Susan Morris & Guest Callers, (425) 591-8692
DANCING SHADOWS Rounds, 1st & 3rd Sat 7:00-9:30 pm @ Juanita Community Club, Kirkland – Debbie & Paul Taylor, (425) 478-5128
DUDES AND DOLLS MS, 2nd, 4th & 5th Fri 7:30-10:30 pm @ Cedar Valley Grange, Lynnwood – Scott Coon & Guest Callers/Debbie Taylor, (425) 337-2906
FERN BLUFF SQUARES MS, Family, 2nd Sat 7:30-10:30 pm @ South Lake Stevens Senior Center, Lake Stevens – Ray Gallagher/Linda Nold, (425) 334-5184
FIDALGO FOGCUTTERS Plus, 1st & 3rd Fri 7:30-10:00 pm @ Skagit Valley Grange, Sedro-Woolley – John Corrigan-1st Fri and Guest Callers-3rd Fri, Bob Berka, (360) 387-8727
FREEWHEELERS MS, 1st & 3rd (some 5th) Sun 7-10 pm @ Mountlake Terrace Senior Center, Mountlake Terrace – Roger Spiese/Debbie Taylor, (206) 992-4932
HAPPY HOPPERS MS, 1st & 3rd Sat 7:30 –10:30 pm @ Stillaguamish Senior Center, Arlington – Guest Callers/Guest Cuers, (425) 367-7645
HAPPY ROUNDERS Rounds, Ph 3-4, Tues 7:30-9:30 pm @ The Hayloft, Lynnwood – Randy Preskitt (425) 348-6030, (206) 364-4173
MT. BAKER SINGLES MS, 2nd Fri 7:30-10:30 pm @ Skagit Valley Grange, Sedro-Woolley – Dave & Bonnie Harry (360) 391-5620
MT. BAKER TEACHERS/CALLERS/CUERS Info Contact: Susan & Larry Morris (425) 881-0691 CallerSusan@gmail.com
RAINBOW SQUARES Pre-Rounds 7:00 pm; MS, 2nd & 4th Sat 7:30-9:30 pm at Ten Mile Grange, Lynden – Brent & Therese Mawdsley, (360) 733-4487
SAMENA SQUARES MS, 2nd & 4th Fri 7:30-10:30pm @ Juanita Community Club, Kirkland – Guest Callers/Cuers - (425) 820-4188
SHIRTS-N-SKIRTS MS, Teens, Wed 6:30-9 pm @ Cedar Valley Grange, Lynnwood – Randy & Marie Preskitt - (425) 348-6030
SKAGIT SQUARES MS, 3rd Sat 7:30-10 pm @ Mount Vernon Senior Center, Mount Vernon – John Corrigan/Bob Berka - (360) 424-4608
SKY VALLEY WHIRLWINDS MS, 3rd Fri 7:30-10:30 pm @ Triway Grange, Mill Creek – Guest Callers/John Neverdowski - (425) 337-3658
STANWOOD SASHAYERS MS, 4th Sat 7:30-10:00 pm @ Stillaguamish Grange Hall, Stanwood – Ray Gallagher/Bob Berka - (360) 387-5055
WHIRLYBIRDS MS, 1st Fri & 3rd Sat 7:30-10:30 pm @ The Hayloft, Lynnwood – Dave Harry - (360) 794-0947
WOODINVILLE SQUARE CROWS MS, 1st & 3rd Fri 7:30-10:30 pm @ Sammamish Valley Grange, Woodinville – Guest Callers/Karen Neverdowski (360) 805-1891

Revised 10-8-15

level dance on November 6th, or the Mainstream dance on the 21st? Sorry you missed them?

Well, come this month, then! Level dance on Friday the 6th, also known as First Friday Fun Fest. 7:30-10:30 pm at the Hayloft in Lynnwood, with Dave Harry calling. And bring your friends who haven't started in a square yet. On the other hand, help those not-dancing-yet friends with Thursday lessons. A new class session began on Thursday the 5th of November, 7:15 pm.

Then, on the third Saturday, December 19th, is the regular Mainstream Dance with Dave Harry calling and Roxanne Boelter cueing. Dancing starts at 7:30 pm with Plus Tip and Rounds, and Mainstream from 8:00-10:30 pm. Bring your friends, and meet some new ones.

All of this happens at The Hayloft, 15320 35th Ave. W., Lynnwood

Jim Erickson,
charjim2213@gmail.com

Susan Morris
Square Dance Caller
Basic, Mainstream, Plus & Contra
www.callersusan.com
susan@callersusan.com 425-591-8692

PI-R SQUARES
Dec 12th (2nd Saturday):
"Holly Jolly Dance"
Student Level
Andy Garboden, caller ~ Kyle Quande, cuer
Come dance with us!
Dec 26th (4th Saturday):
"Christmas Memories"
Andy Garboden, caller ~ Kyle Quande, cuer
W/S 7:30 - 8:00 pm • MS 8:00-10:30 pm
Good floor • Hearing enhancement • 425-432-0138
Meridian Grange ~ 15422 Kent-Kangley Rd, Kent
more information on web site:
www.pi-r-squares.org



June 17-18, 2016
Longview, Washington

First Fridays... *New dancer level!*

with Dave Harry (7:30 Dance time)

Third Saturdays... *Mainstream!*

with Dave Harry (squares)

and Roxanne Boelter (rounds)

7:30 Plus 8:00 MS

Hayloft: 15320 35th. Ave. Lynnwood

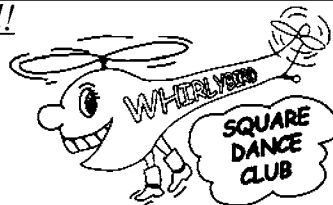

Large Hall!--Bus Caravans Welcome. Come Join The Fun!

Dance with RAINIER COUNCIL Clubs!

Website: squaredance-rainier.org (look for Calendar)

MONDAY

Every **ROUSE-A-ROUNDS**
Lorraine & John Rouse

Collins Grange
6:30 Beg, 8-9:30 Phaze 2/EZ3
Dance 4th Mon, 7-10
253-846-8203

WEDNESDAY

Every, **EVERGREEN ROUNDS**
except Tom Tomlinson, Charles
3rd Morehead

Riverside Grange
6:30-8:00 teach; 8-9 2,3; 9-10 4,5
253-927-2887, 253-229-9443

THURSDAY

2nd & 4th **SWINGNUTS**
Don Wood
(Oct-May)

Sumner Valley Square Dance Hall
8:30-10:00 B-51/MS (squares-only)
253-200-4566

FRIDAY

1st **SPINNERS**
Greg Weber/Sue Weber
(Sept-June)

Buckley Hall
7:30 PreRds, 8-10:30 MS/Rds
360-829-0251

2nd **YOUNG BUNCH**
Mark Sebree/Sue Weber

Collins Grange
6:30 PreRds, 7-9 MS/Rds
253-472-9092

2nd & 4th **SWINGING SQUARES**

Andy Garboden/Lorraine Rouse
(2nd & 4th Friday, Sept-June)

Sumner Valley Square Dance Hall
7:30 PreRds, 8-10:30 Plus/Rds
253-841-9656; break @ 9:15

SATURDAY

1st **NW CALLERS ASSOCIATION**

Cedar Grange
253-445-4691; mtg; dances TBA

1st & 3rd **SOUTH SOUND SINGLES**
Jess Thomas/guest cuers

Collins Grange
7:30 PreRds, 8-10:30 MS/Rds/+Tip
253-851-5773

3rd **SWINGNUTS**
Don Wood/Marie Wood

Sumner Valley Square Dance Hall
6-8 MS (squares only), 8-10 Plus/Rds
253-200-4566

2nd & 4th **BONNEY LADS 'N' LASSIES**
Greg Weber/Lorraine Rouse
(July & August, 2nd Saturday)

Collins Grange
7:00 PreRds, 7:30-10 MS/Rds/+Tip
253-875-5380

2nd & 4th **ROAMIN' TACOMANS**
Tom Tomlinson - caller/cuer
(July: 4th Sat-MS; Aug: 4th Sat-Plus)

Sumner Valley Square Dance Hall
7:30 PreRds, 8-10:30 MS/Plus/Rds
253-848-7073 (2nd Sat Plus, 4th Sat MS)

SUNDAY

2nd **LEGION SQUARES**
Jeff Graeff/cuer TBA
(Please call about dances.)

American Legion Post 138
6-9 MS/Rds; W lessons
253-720-2788

3rd **RAINIER CALLERS & CUERS**

San Souci Mobile Estates
253-229-9443

NORTH CENTRAL COUNCIL

Jackie & Del Chase
Area Reporter
509-764-4254
deljackiechase@nctv.com

BUDS & BLOSSOMS: It is Christmas time; the leaves are gold and brown, hopefully by now we have snow somewhere. We have survived our Thanksgiving feast and ready to start our holiday baking. (Christmas cookies)

It is with a sorrowful heart that we had to say “see you later” to our founding caller and friend Sterling McKenzie. Sterling went to spend eternity with his maker, and family members that has gone before him on October 12th. His service was on October 20th. With a wonderful attendance from the Square Dance family to share their stories with his family. Square Dance community was represented by the State, Council, and Club levels. Thank you for your support at this time of need.

Keep Vonnie Spence and family in your Prayers at this time of need. We are so sorry about losing Jim.

On to the current news our anniversary dance is Friday December 11th with Eddie Harry calling and Nora Jackson cueing. The dance will start at 7:30 pm Mainstream with no Pre-rounds. This dance will have a Hawaiian theme so get out your Hula skirts, Hawaiian shirts and your lei's and join us.

We will be dark on December 18th to have a combined Christmas Dance with the Cascade Twirlers on December 19th. We will also be dark on December 25th for the Christmas celebration.

Merry Christmas to all!

Don & Nora Jackson, noralcooper@yahoo.com

CASCADE TWIRLERS October 3rd dance a lot of fun. It was our annual MENS NITE OUT dance, where the men were worth their weight in GOLD. Katy Harper & Kayla Huber were our caller and cuer. They did a professional job of keeping us dancing and having fun. October 17th we cancelled and traveled to 4x8s in Moses Lake. David and Sharon did a great job of keeping our feet moving. The 4x8s are such a friendly club it is hard to not have a good time.

Appleland Promenaders had a special anniversary dance, one they will remember for a long time, as will the dancers. They will elaborate on it in their report. It is things like this that keeps dancers resourceful and entertained.

December 4th dance we will share with Appleland Promenaders with Steve Noseck calling and Noelle Miller cueing. Jim Spence was supposed to share the program, but alas we are all saying prayers for Vonnie with the loss of Jim. Our December 5th dance is cancelled because of the December 4th dance. December 19th we are co-hosting a Christmas Party dance with Buds & Blossoms. Don Jackson will be calling and Marilyn Holman will be cueing.

January 2nd we will CRUISE INTO THE NEW YEAR, with Jim Compton calling and Marilyn Holman cueing. It should be smooth sailing. Have a very Merry Christmas and a Happy New Year

Noelle Miller, noelemcues@charter.net

4 X 8's have settled into the fall routine of classes, dances, fundraisers and life's ups and downs.

Class has been going well. Dave is teaching with new ideas and the new dancers seem to be catching on faster than usual. They have after only 6 classes exceeded our expectations. Good job Dave! Dave is also holding plus lessons on Saturday mornings for any interested in honing their skills.

Cascade Twirlers and Wheatland Whirlers visited our dance on October 17th. It was great to have 5 squares on the floor. On Saturday, October 24th we held our Highway 17 clean up and we found many interesting items to add to our



Left: Road sign that designates the section of Hwy 17 that 4 X 8's clean twice a year. The youth (above) who help all get community service certificates for their work.

Photo by Judy Carlson



pile of trash. We could have made soup with all the different veggies that lost their way to the processing plants and with scattered fishing lures we could have made a full meal if we could have caught a badger from one of their many holes... well maybe I'm stretching it a little. Ha Ha!

Patti Roberts, pattiroberts@ifiber.tv

Fall dancing fun for the **APPLELAND PROMENADERS** included the Winthrop dance and, in October, many APs caravanned to the west side to dance with the Happy Hoppers and the Fidalgo Fogcutters. Callers John Corrigan and Tom Roper filled the dance weekend. It was a fun time; they retrieved their banner from the Fogcutters and hey, the APs brought home banners from both clubs! That means more fun in the future. The APs really maximized their time as they also danced with the Eastside Plus on Saturday afternoon.

The busy month of December begins with a shared dance with the Cascade

Twirlers on December 4th to caller Steve Noseck. Plan to come at 7 pm for Plus. Noelle Miller will cue. Tom Clymer will travel to Moxee on December 5th with a group to join the Gateswingers in celebrating their anniversary. On December 12th, the APs host guest caller Dave Boggs; Sharon Boggs will cue. The years winds down with Tom Clymer calling a celebratory New Year's Eve dance on December 31st. The AP members send wishes for good health and good dancing to you all in 2016.

Kay White, kwhite@nnwi.net

First off I need to apologize to **WHEATLAND WHIRLERS** as I made a mistake and said pre-rounds were at 7:30 and Mainstream was at 8:00, but it should have been pre-rounds at 7:00 and Mainstream at 7:30. If I messed anyone up I am sorry.

Wheatland Whirlers lessons are progressing very well and the Tuesday and Thursday evenings seem to be working.

We cancelled for Appleland Promenaders anniversary dance on October 10th and on October 24th we had our Halloween dance with **CRAZY TIES**. We had fun moving to the calling of Jim Compton and the cueing of Noelle Miller and her Halloween music. We had some students come out and Jim called so they could dance. What fun!

December 7th the club is going to have a Christmas Party with a Progressive dinner for its members. This should be a good time for all. On December 11th we will attend **BUDS & BLOSSOMS** anniversary dance to help them celebrate. December 12th will be our Christmas dance with Jim Compton calling and Noelle Miller cueing.

January 9th will be our Snowflake dance with Jim Compton and Noelle Miller. And on January 23rd will be our **HOBO DANCE** and we will be serving chili at 6:00 and start dancing at 7:30, there will be no pre-rounds.

Merry Christmas and a Happy New Year to all!

Noelle Miller, noelemcues@charter.net



Above: Wheatland Whirlers and right: Cascade Twirlers visited the 4 X 8's on October 17th.

Photos by Patti Roberts



Trish Gaine
Area Reporter
360-683-2409
fasolard@olypen.com
<http://gardinerwa.org/noc/default.htm>

You know you have a great batch of students when they all come in costume to the Class Level Halloween Dance. The **RHODY O'S** danced four squares that night with lots of ghouls and goblins.

Our Christmas schedule is so full. Get ready to take some notes. The Rhody O's only regular dance will be held on Friday, December 4th, with Rounds at 6:00, MS Workshop at 7:00 and dancing at 7:30. Our special Christmas Dances will be held on: Tues, December 15th, for a Class Level Christmas dance-Rounds at 6:30 and MS dancing at 7:30 and Thursday, December 17th, for our 4PLUS4 club's Christmas Dance. Advanced rounds at 5:30, Intermediate Rounds at 6:30 with PLUS dancing at 7:30. Friday, December 18th, will be the Rhody O's Mainstream Christmas Dance with Rounds at 6:00, MS workshop at 7:00 and the MS dance at 7:30.

But the big blow-out of our year is the Rhody O's and 4PLUS4's New Years Eve Dinner Dance on Thursday, December 31st. Dinner starts at 7:30 with MS, PLUS and A dancing till midnight. Our call/cuer is Spike Reid and we dance at the Gardiner Community Center. For dinner tickets contact Spike or our club president, Dave Johnson, at chinook_6@hotmail.com. Our hall will be dark starting Tuesday December 22nd thru Wednesday December 30th. Come join us for a truly memorable New Years Eve celebration.

Rhody O's hope you have a heartfelt Christmas celebration with family and friends and remember to share whatever you can - even it's just a smile!!!

Trish Gaine, fasolard@olypen.com

CENTRAL PUGET SOUND COUNCIL

From page 27

to these dances where they can get used to dancing with a different caller and meet more square dancers in the community as well as getting into the fun of our "Raffle" Dance.

If you are in the Kent area on Saturday, December 5th and/or December 19th, please stop by and dance to the Calling of Wayne Easton and the Cueing of Lorraine and John Rouse at the Meridian Grange on Kent-Kangley. To you and your family and friends, may the New Year of 2016 be a year of many Blessings and wonderful Health!

Donna Rohde, donnalou13@comcast.net

PENINSULA COUNCIL

Kitty & Paul Ogg

Area Reporter

360-692-6032

kjoggpr@aol.com



SQUARE STEPPERS wish you all a very Merry Christmas. This is a busy and exciting time of year. Thanksgiving is over and now we're getting ready for Christmas. It is a beautiful time of year with all the lights.

Gunter Monroe called for our November dance and we all had fun dancing to him.

Square Steppers' Holiday Dance will be December 12th with Spike (Betty) Reid calling.

Square Steppers is a Plus Club that dances on the second Saturday of each month from 7:30 to 10 PM.

Barbara Pennington, bardeldry@gmail.com

PAWS & TAWS held a Craft Fair/Silent Auction November 6th and the money collected will be used to purchase gifts for the Christmas Angel. They have done this for many years. It is always appreciated by the family who is in need at this time of the year.

The 3rd Friday in November was their Sport Theme Dance where the people come as their favorite sport. It is always fun to see what they wear.

Classes are going well and we are looking forward to January when Mainstream classes start. We are always looking for new dancers.

We took the time to enjoy Thanksgiving and all the crazy shopping days as Christmas is not far behind.

Leota Lewis, leotal@msn.com

ROUND SQUARES are keeping our caller Willie Sewell in our thoughts and prayers as he continues his rehabilitation at home. Missy has been a full time caregiver with lots of TLC to get him well.

KSDC went dark October 10th so there could be a council visitation to Lac-A-Do Hall in Olympia. Everyone met at the hall that carpooled, and the others met at Lac-A-Do. A great evening of dancing was enjoyed by all.

It's time to decorate the hall once again for the upcoming holiday festivities. All the clubs work together under the guidance of Decoration Chairman Sheila Blackburn with bright colors and lights around the walls.

Round Squares send many thanks to Gunter Monroe for being the guest caller for our October and November dances.

Our Christmas Dance will be December 19th. Please come join us. Hope everyone has a Merry Christmas and Happy New Year!

Betty Force, Reporter

DUDES & DOLLS are brushing up on our Plus square dance figures every Monday afternoon which is keeping most of us on our toes, or at least on our feet! Two to three squares meet at the Kitsap Square Dance Center at 1:00pm for 2 hours of workshop and fun with caller Don (Donna Harbert) Smith.

Bob and Janet Bowmer meet us at the treasurer's desk and may have already started the coffee. An endless supply of goodies seems to appear like magic, thanks to all the good cooks in our midst. Russ & Ruth (current president) Richardson are always there to keep things running smoothly.

We are reviewing the Plus figures and getting exposed to some new formations of those figures. Anyone who has recently learned the Plus moves or who wishes to brush-up on plus moves is more than welcome to attend.

We will have our Christmas party on December 14th which will be the final get together for the year.

Monday, January 5th 2016 will be our first get-together of the New Year.

Merry Christmas and Happy New Year to all!!

Joan McLean, mcleancnj@harboret.com

THE CLUBS OF



NORTH CENTRAL COUNCIL



INVITE YOU TO JOIN THEM

Appleland Promenaders-Mainstream • www.applandpromenaders.com

1st Fri, 2nd & 4th Sat. East Wenatchee Grange, 3400 Sunset Hwy. East Wenatchee

Contact: Bob & Connie Mulholland, (509) 881-4961 or sqdncr@nwi.net

Buds & Blossoms-Mixed Level

2nd/3rd/4th Fri. East Wenatchee Grange, 3400 Sunset Hwy., East Wenatchee

Contact: Don Jackson, (509) 670-3540 or imt655@hotmail.com

Cascade Twirlers-Mainstream

1st & 3rd Sat. East Wenatchee Grange, 3400 Sunset Hwy. East Wenatchee

Contact: Noelle Miller, (509) 884-0497 or noellemcues@charter.net

Moses Lake 4X8's-Mainstream

1st & 3rd Sat. Moses Lake Senior Center, 608 E. 3rd Ave., Moses Lake

Contact: Del & Jackie Chase, (509) 764-4254 or deljackiechase@aol.com

Plus Bunch-Plus Level

Wed. 1st & 3rd Dance; 2,4,5 W'shop East Wenatchee Grange, 3400 Sunset Hwy, East Wenatchee

Contact: Tom Clymer (509) 293-3516 or Tom.Clymer@charter.net

Wheatland Whirlers-Mainstream

2nd & 4th Sat. Ephrata Senior Center, 124 C Street NW, Ephrata

Contact: Judy & Harold Schock, (509) 754-4803 or jaschock@homenetnw.net

Tri County Callers and Cuers Association

Contact: Dave & Sharon Boggs, (509) 787-4099 or grizzlyboggs@aol.com

All Clubs Dance September through May with Some Summer Dances



RAINIER COUNCIL

Lane Johnston

Area Reporter

253-200-4566

www.squaredance-rainier.org

lanej@chessmenkastle.com

RAINIER COUNCIL clubs wish nothing but happiness and fulfillment for all of our square dance friends as we close out 2015 and transition to new beginnings in 2016! There were lots of changes among our council member clubs this past year (some good: e.g. new callers/cuers, new dance formats, some larger classes than in the past, etc.; and some “not-so-good”: struggling or folding clubs). But we’re committed to doing more to keep our activity vibrant and relevant in the face of many competing demands on our leisure time (social media, cable TV, Seahawks, Mariners, etc.).

The entire dance schedule for any Rainier Council club (individually) can be found by entering the club name in the Club Name field on the SCHEDULE tab of the WheresTheDance.com website. For a combined calendar listing all Rainier Council clubs at once, simply enter “Rainier” in the Club Name field and select the “WA State-Rainier Council” listing.

As a reminder, clubs listing 2016 dance calendar events on WheresTheDance before the end of 2015 will be given “Charter Membership” status for life on the WTD website. This means they will be allowed to post their dance schedules AND flyers on the site forever at no charge!

Lane Johnston, lanej@chessmenkastle.com

Happy Holidays from **SWINGING SQUARES**. We hope you all had a great Thanksgiving. A big thank you to all who participated in our 5th Holiday Bazaar (whether as a vendor or a guest/shopper) to make it a great success.

We invite you to our Come Celebrate Christmas dance on December 11th, 2015 at the Sumner Dance Center, 1705 Willow Street, Sumner, WA 98390. Rounds will be cued by our Great Cuer Lorraine Rouse (John) beginning at 7:30 and Squares will be called by our Super Caller Andy Garboden (Tricia) from 8-10:30. We will only have one dance in December due to Christmas falling on the 4th Friday.

We wish you all a Merry Christmas and A Happy New Year!

Lorraine Kramer, mlorrainek@live.com

The **YOUNG BUNCH**’s “Dear Santa” letter:

We have been good kids this year Santa. Okay, we weren’t always super nice to our siblings, and maybe we didn’t always listen to our parents, but we

have basically been good. We would like to have a nice big dance at our Friday, December 11th dance, starting at 6:30 pm, for our parents. Our parents work really hard trying to keep our club going with little money.

If you could make sure and tell the other adults in our council how much we miss them and would love to see them that would be great. Could you tell them we might not be perfect kids at the dance but we will be glad to see them (and our parents will dance with them because they like to dance too)?

We are gonna have Christmas cookies and cocoa, so that will be good.

Santa, we would really like to see our parents smiling and having a nice dance for them would make them smile cause then they would know their hard work is paying off. Oh...and if you could make sure all kids get a present, we would like that too.

We love you Santa.

Rachel Ulmer - Youth Reporter

Leslie Young - Adult Adviser, Pollyanna1962@gmail.com

The **SPINNERS** would like to thank everyone that came to the “Sports” dance in October. We had a really fun time and hope all of the guests had a fun time also. Our caller and cuer (Greg and Sue Weber) dressed in Seahawks outfits, and did an outstanding job keeping everyone on their toes. There was a lot of Seahawks stuff at the dance, including door prizes.

The Friday, December 4th dance is our Ornament exchange dance. Bring an ornament and you’ll take a different one home with you. It’s always a lot of fun. There are always some really nice ornaments and, well, some we’ll just describe as “different”. We dance at the Buckley Hall in downtown Buckley. Come join us. We have lots of fun and a pretty good potluck also.

Dave Percy, skidave@comcast.net

[Rainier Council “Area Reporter’s” note: the Spinners dance on Friday, December 4th will also be a dance honoring Dave and Nina Percy as recipients of the 2015 President’s Award (selected by State Federation Presidents Frank and Kathy Chase) for their exceptional service to the square dancing community. Come out and show your support for this deserving couple.]

The **ROAMIN’ TACOMANS** want to wish you all a very merry Christmas and the best of everything in 2016. We want to thank you for dancing with us this past year.

Our plus dance on December 12th will be a festive event and will include a silent auction so you can finish (or start) your Christmas shopping. By December 26th all the rushing to get ready for Christmas will be over, so come relax with us at our post-Christmas Mainstream dance. Tom Tomlinson is our very talented caller/cuer. Rounds start at 7:30 pm and the dances start at 8 pm.

Our hall is at 1705 Willow St. in Sumner.

We continue our Plus lessons every Sunday from 5 to 7pm. We have 13 students and usually have about 4 squares with angels. Angels dance for free and Tom cues Rounds between tips. If you dance Plus, come and join us for a fun time.

Sharon Herman, tonysharp@yaho.com

Hi from **SOUTH SOUND SINGLES**. We hope to see you all at our dances as we have a new Caller (Jess Thomas) and Cuer (Shawn Cavness). We dance 1st and 3rd Saturday at Collins Grange.

Our beginning square dance lessons have begun, so please if you have anyone that would like to get some additional floor time, send them our way. Classes are on Wednesdays from 7pm to 9 pm. See you there!

Cecilia Graeff, Cecilia_graeff@yahoo.com

The **SWINGNUTS** dance at the Sumner Valley Dance Hall, 1705 Willow Street in Sumner, WA with Caller Don Wood and Cuer Marie Wood.

Our dance schedule continues to “evolve” to meet the needs and desires of our club members and the local square dance community. Beginning December 19th, our 3rd Saturday dance format will be a PLUS session from 7-8:30 pm, followed immediately by a MAINSTREAM session from 8:30 pm-10 pm. Both sessions will include a single Round between tips.

Our very first B-51 “Beginners” class “Graduation Dance” will be held Thursday December 17th from 7-9 pm. We’ve had excellent “angel” support for the class, but would love to see as many experienced dancers as possible come out and congratulate the new dancers on their achievement. We’ll start the next 10 week B-51 Beginners class the first Thursday in January.

We still have presale tickets available for the New Year’s Eve Dance (see our full-page ad in this issue of Footnotes for details). It promises to be a very special and memorable evening!

We will be DARK on the 1st Saturday of the month.
Come and Dance and have FUN with the SwingNuts!

Gail Johnston, gailj@chessmenkastle.com

Well hello again from the **BONNEY LADS ‘N’ LASSIES**. We had two great dances in October! First, we would like to thank everyone that came to our Dance for the Cure Dance on October 10th to benefit The American Cancer Society. The club recruited quite a few people to help with the decorations and they turned out awesome. With the support of our Square Dance Family’s donations, Greg and Lorraine donating their pay and the club donating the net proceeds, we were able to donate \$653.00. You are all amazing and we really appreciate your support!

We want to remind everyone that we’ve scheduled only have one dance

in December...it is our Christmas Dance on Saturday December 12th. Pre-rounds begin at 7:00 and the dance is from 7:30-10:00. We hope to see all of you there, but if we don’t see you on the 12th, we want to wish you all a Very Merry Christmas and we hope Santa brings you all of your Christmas wishes. Please have a fun and safe New Years and we look forward to dancing with you next year. Well that’s all for now, so to all of our friends, keep dancing, but most of all keep smiling.

Ron & Linda Sferrazzo, sferrazzo5@msn.com

FLUTTERWHEELS
1st Saturday 7-10 pm Mainstream
+ 3rd Saturday 7:00-9:30 pm Student Level
Don Wood, Caller • Ron Woolcock, Cuer
+ Glenn Raiha, Caller Guest Cuer
Lac-A-Do Hall-1721 46th NE, Olympia, WA
Sound Enhancement + All Dancers Welcome

BONNEY LADS ‘N’ LASSIES
Mainstream, Plus Tip
2nd & 4th Sat Sep - Jun, 2nd Sat Jul & Aug
Pre-rds 7:30 - 8 MS w/+ tip 8 - 10:30 PM
GREG WEBER, Caller
LORRAINE ROUSE, Cuer
Collins Grange 3404 - 120th St E Tacoma

RUFF & RUFFLES
3rd Saturdays, 7:30 pre-rounds; 8-10:00 p.m. MS
Jim Raupp, Caller
Susan Healea, Cuer
Catlin Grange, 205 Shawnee Street, Kelso
Using Williams Sound System
LAST SCHEDULED DANCE FEBRUARY 20TH, 2016

COUGAR SQUARES
1st Sat Sep-Jun
PLUS 7:30 MS 8 - 10:30 PM
3rd Thurs Jul (7 PM) / 1st Thurs Aug (7 PM)
Sound Enhancement
Caller/Cuer - JIM RAUPP
St. Francis Rectory Hall/Spencer Rd.
off Jackson Hwy. Toledo, WA 

STARDUST DANCERS
Round Dance Club
SUSAN HEALEA, Cuer
1st & 3rd Thursday 7:30 - 9:30 PM
Catlin Grange #199
205 Shawnee St., Kelso, Washington

ROUND-A-BOUTS
Lac-A-Do Hall -- Olympia
1st Tuesday & 3rd Fridays
7:30 - 9:30 PM Phase 2 & 3
Ron Woolcock - Cuer & Instructor

SQUARE 1 PLUS
1st Friday - 7:30 - 10:00 PM
3rd Sunday - 6:30 - 9:00 PM
Gunter Monroe Caller
Guest Cuers
Lac-a-do Hall, Olympia, WA
Info: 360-754-1830

Swinging Squares Plus Club
2nd & 4th Fridays Sep - June
Pre Rounds 7:30-8 PM Dance 8-10:30 PM
Caller: Andy (Trisha) Garboden
Cuer: Lorraine Rouse
Valley Square Dance Hall
1705 Willow St - Sumner, WA

South Sound Singles
1st & 3rd Sat. Dark: 6/18/16 & 7/2/16
Pre Rounds 7:30PM • Dance 8-10:30PM
Caller: Jess Thomas
Cuer: Guest Cuers
Mainstream/Plus tip at end
Info: 253-851-5773
Collins Grange 3404 - 120th St. E., Tacoma

R SQUARE D
2nd Friday & 4th Saturday
Plus 7:30 - Lonnie Sycks, Cuer
Mainstream Dance 8 - 10 PM
Craig Abercrombie, Caller
Annual OCTOBERFEST 1st weekend Oct.
360-425-0583 or 360-636-3358
Kelso Senior Ctr., 106 NW 8th Ave., Longview, WA

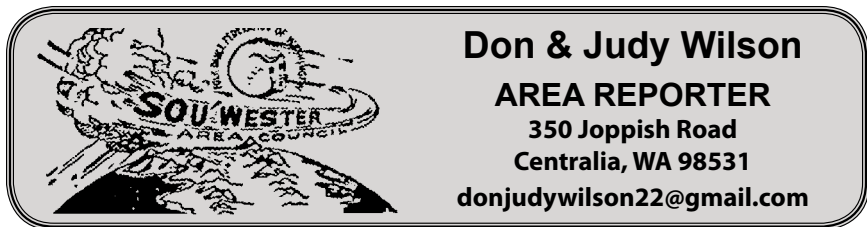

Don & Judy Wilson
AREA REPORTER
 350 Joppish Road
 Centralia, WA 98531
 donjudywilson22@gmail.com

SOU'WESTER COUNCIL clubs wish everyone a Merry Christmas and a great holiday season filled with lots of dancing! Many clubs have special dances during the holidays, some with dinners others at different venues and/or times. Be sure to check in Footnotes for current information. Also remember that June 19th and 20th Sou'Wester Council will be hosting the Washington State Festival in Longview. Registration would make a great Christmas present for any dancer.

Hard to believe it is December already. **HARBOR HAYLOFTERS** are having their Christmas Dance on the 19th. Our guest caller is Dick (Diane) Russell. We are hoping to visit Cougar Squares for their Christmas dinner and dance, and Prairie Steppers. Haylofters are planning their Christmas party and I know that our caller, Randy (Kris) Carlson, is on Santa's list.

In October we attended Oktoberfest in Kelso, traveled to Olympia for the Do-Si-Do's Anniversary Dance and enjoyed the calling of the Front Porch Trio with Jim Hattrick, also visited R Square D and the Council Dance. Our Anniversary Dance was great fun with visitors from Square Ones, Prairie Steppers, R Square D, and our State President, Gene and Tanya Currier. We had our first cake walk and lots of desserts were won, after all we are trying to keep our weight up. Twenty of our members danced at Channel Point Assisted Living Facility.

November we visited Cougar Squares, Prairie Steppers, and R Square D. We had our Veterans Dance on November 21st.

The first of our Snow Birds have left and are headed "South" for warmer weather. We wish them safe travels and wait for their return in the spring.

This is wishing everyone a very Merry Christmas and a Happy New Year; we hope to visit some of you next year.

Ann Kilwien, sqcamper@comcast.net

Because the **SALTY SASHAYERS** are a travel club and only host one dance a year, you don't hear from us very often. But Saltys want you to know we are still an active club and traveling all around. Some of the places you may have seen a Salty or two are: the 2015 State Festival in Mt. Vernon; the Education and Leadership Seminar at Circle 8; USA West in Helena, Montana; R Square D's Oktoberfest Dance; Olympia Do Si Do's 66th anniversary dance; Harbor Haylofters' 50th anniversary dance; Peninsula Council's Turnbuckle dance; Fidalgo Fogcutters' dance honoring this year's President's Award couple Ellen

Ostrum and Doug Keyes; and all of the Sou'Wester Council dances.

We scan every issue of Footnotes for special dances to attend, so make sure you let us know if you have any dances coming up you would like us to attend. Keep safe and happy dancing!

Bonnie Blewett

Please join **DO SI DO'S** on December 12th as the Do Si Do Square Dance Club members usher in the mid-winter holidays dancing to our 'Jingle Bell Rock' theme. Jim Hattrick returns as our regular caller and Joyce Sebree will cue.

Holiday seasons can be both wonderful and challenging. For years the club has supported SafePlace Olympia during the holidays by donating small travel/trial sized personal hygiene or toiletry items. The local program is dedicated to help those who have been subjected to violence and may be homeless. We encourage and appreciate attendees who join us in supporting this deserving program. Monetary contributions are useful.

Craig Abercrombie was our guest caller during November's dance that celebrated the contributions of our 'Men and Women in Uniform'. He and Joyce put us through our 'paces' during the evening. We had great fun and enjoyed honoring current and former military members who served our country.

Thanks to the many travellers who crowded Lac-A-Do Hall to make our October's 66th Anniversary celebration so wonderful! It was even more special to welcome back Jim Hattrick, joining Craig Abercrombie and Adam Christman to complete the 'Front Porch Trio'. Joyce Sebree, as always, expertly cued the round dancers.

We dance every second Saturday of the month at Lac-A-Do Hall (1721 46th Avenue NE in Olympia). Pre-rounds begin at 7:30 pm and Mainstream/Plus Tips follow at 8 pm until about 10:30 pm. We encourage students who have finished the B51 level and up from our OASDI classes to join us and practice their 'moves'. As always, we offer delicious treats during break and door prizes for those who traveled to the dance. Join us in our monthly celebration of the Do Si Do club and Square Dancing!

Katherine Deuel,

The **SQUARE ONE PLUS CLUB** has been having a lot of fun with our very successful Plus Workshops, put on by our Caller, Gunter Monroe. We have them once a month and have between two and three squares. We are learning to do DBD Plus dancing and are being challenged, while having a great time. Our Workshops will go through December, then our Plus lessons will start on the 4th Sunday of January.

Our switch to casual attire, with square dance attire appreciated, theme has been very successful. We have been having four, or more, squares at each of our fall dances. We find that a lot of the newer dancers appreciate the fact of being able to be a little more casual than traditionally, and this old dog does, too. The

Square One's main focus is getting people on the dance floor having a great time. We hope to see you in a square.

Good dancin' to you all!!

Ken Moller, ckmoller@outlook.com

RUFF AND RUFFLES are still enjoying the "4th Friday Social". Dave and Marge Martin hosted the September evening in their home. They had prepared ingredients for a salad but the main food was "ordered in pizza". We enjoyed some socializing and then played a few table games. This helps keep us more in touch with each other when not dancing.

Since Catlin Grange was in use, we moved our October 17th dance to St. Francis Hall in Toledo. It was quite a night. Callers Jim Raupp and Neil Rosevear and cuers Susan Healea and Jim would try to catch one another off guard and then make the other one continue the call or cue. Sure kept every one on their toes. Three squares enjoyed the crazy, fun evening. Rosevears and Fred and Peggy Rolf were on kitchen committee. We also extend sympathy to two club members who lost loved ones in October, Fred Rolf a brother and Betty Clifton a son-in-law and a niece.

Coming up is our Christmas dance December 19th at Catlin Grange with Jim and Susan as caller and cuer. Then on December 31st Ruff and Ruffles and R Square D will be co-hosting a New Year's Eve Dance at Catlin Grange. This dance will have a full evening of dancing starting with Plus at 8 pm, Pre-rounds 8:30 pm and Square dance at 9 pm. Jim Raupp will be the featured caller with Susan Healea the featured cuer. We invite you to come dance with us and welcome in the New Year.

We wish everyone a happy and safe holiday season.

Betty Clifton, sqkats@q.com

The **PRAIRIE STEPPERS** wish all of you a very Merry Christmas!

We had just two squares on the floor at our October dance but those who attended had a great time. Youngest Prairie Stepper Ann Manes as Little Red Riding Hood greeted the dancers while Gretchen Kunkel and Mary Niccoli hosted the festivities. Photo of all of them plus Prairie Stepper Pat Colton in costume at right. Thanks to Vice President Tim Palumbo for filling in to officiate at dinner break in



Prairie Stepper costumed greeters

Photo by Shirley Spain

President Mike Freels absence. We enjoyed our travel to the Saturday night R Square D Oktoberfest dance at the Rose Valley Grange.

We hope you enjoyed our November dance in Honor of our Veterans hosted by Dick and Diane Russell. They planned our travel to the Silver Stars dance at the end of November. And we hope you'll plan to join us for our December 12th dance hosted by new members Roger and Kathy Vallery. Santa will be on hand to dispense gifts to all of our guests. Our travel for December is to the Cougar Squares Thankful Christmas Dance.

We have eight new and returning dancers for our Basic 51 lessons and nine dancers attending our Plus lessons with Don Wood providing excellent instruction. Thanks to Glenn Raiha for subbing for Don at the end of October. We plan to start Mainstream lessons in January 2016.

We extend our sympathy to Marie Wood on the passing of her mother Doris Jenks. Prairie Stepper Mary Niccoli and cuer Lonnie Sycks were both scheduled to have knee surgery in late November. We wish them a speedy recovery.

The Prairie Steppers raised \$255.80 to be donated to the Lions' Camp Leo for diabetic children at the Oakview Grange Rummage Sale on October 2nd and 3rd. Our storage room at the Grange has been totally remodeled by Bob Spain with help from Shirley Spain, Gretchen Kunkel, and Mike and Marion Freels. Many thanks to Bob for all his hard work. The Grange planned to honor the Prairie Steppers as their choice for Best Club in Lewis County at the Grange meeting on November 12th.

Find flyers for all of our upcoming dances at www.thesteppers.org.

Marion Freels, M_librarian@yahoo.com

R SQUARE D kicked off the beginning of October with our big event of the year, the weekend of Oktoberfest. It was held at the Rose Valley Grange and clubs from around the Northwest all came to enjoy the fellowship of eating a German feast together. Once our bellies were full we let it settle as we enjoyed the River City Riders put on a show to remember. It was followed up with 10 squares of dancers enjoying the calling of Les Seeley and cueing from Tami Helms. Make sure you put this one on your calendar for next year, Friday dance, Saturday Garage Sales, Workshops during the day, a German feast and Breakfast on Sunday.

October 9th found us resting up from Oktoberfest; everyone showed up to dance in Pajamas. Cold cereal was on the menu for the evening snack. Wow, what a busy month it has been, we came to the end of the month with our Heritage Dance on the 24th. Visiting clubs were from Harbor Haylofters, Cougar Squares, Ruff and Ruffle's and Stardust dancers.

December will be a month to slow down and enjoy the Holiday Season. We have a Toy Dance on December 11th and will donate our toys to the needy. This year we are really excited to be co-sponsoring a dance with Ruff and Ruffle's on News Year Eve. Jim Raupp will be our featured caller and Susan Healea will do the cueing. You are not going to want to miss this dance. For more information

please visit our webpage.

For more information about the R Square D club please visit our website at www.r-square-d.info or friend us on Facebook. Caller- Craig Abercrombie, Cuer- Lonnie Sycks

When we recall Christmas past, we usually find that the simplest things — not the great occasions — give off the greatest glow of happiness. ~Bob Hope
See you in a Square in the New Year.

Marie Geisler

STARDUST DANCERS had a great anniversary dinner and dance in October despite some unforeseen problems. November found us celebrating Thanksgiving with lively tunes from Susan's repertoire of fine music. December 3rd will be our silent auction and Christmas Dance with proceeds from the auction going to a charity to be announced. Come help us make this a fun and dance. Hope you all had a wonderful Thanksgiving and Merry Christmas to all.

Linda Sycks

COUGAR SQUARES invite everyone to our Thankful Christmas Dance on Saturday, December 5th. The evening begins with dinner at 6:30 pm and dancing at 7:30. There will be Christmas music all evening, both Squares and Rounds. Jim Raupp is the caller and Susan Healea is the cuer for this festive dance. The location is Toledo Elementary School in the town of Toledo. This is a different location than the usual Cougar dances. Hope you can come and start the holiday season with us!

Lessons for square dancing are held in Salkum on Tuesdays and in Napavine on Thursdays, both begin at 7:00 pm. Jim Raupp is the caller/teacher at both locations. We have several new dancers that are progressing well with basic steps. We will invite them to attend the Thankful Christmas Dance and have an early tip at class level. This is a great way to introduce new dancers to the fun of dancing.

Cougar's Round dance lessons are held the second and fourth Sundays of each month at Baw Faw Grange in Curtis. Susan Healea is our teacher/cuer. The evening contains three parts: Rumba/Cha III/IV, Waltz III and two hours of floor time with mixed level mainly phase II, including a short phase II workshop during the evening. Come join the fun, practice and learning the second and fourth Sundays. Contact Susan or Don and Judy Wilson for more information.

Cougars dance the first Saturday of each month at St Francis Parish Hall with plus beginning at 7:30, mainstream and rounds at 8:00 to 10:00. Jim Raupp is our caller/cuer/teacher and Susan Healea is our Special cuer/ teacher.

Merry Christmas to everyone and hope you can join us December 5th for more personal greetings!

Don and Judy Wilson, donjudywilson22@gmail.com

Come Dance with Sou'Wester Clubs

(Note the changes of locations and days) for some clubs

Tuesday

1st **Round-A-Bouts** Lac-A-Do Hall 7:30-9:00
Ron Woolcock, cuer ROUNDS phases 2-3

Thursday

1st & **Stardust Dancers** Catlin Grange 7:30-9:30
3rd Susan Healea, cuer ROUNDS phases 2-4

Friday

1st **Square One Plus Club** Lac-A-Do Hall 7:30-10:30
Gunter Monroe, caller, Joyce Sebree, cuer PLUS
2nd **Rhythm Rounders Fun Dance** Lac-A-Do Hall 7:30-10:00
Randy Wulf, cuer ROUNDS phases 2-5
2nd **R Square D** Kelso Senior Center 7:30-10:00
Craig Abercrombie, caller, Lonnie Sycks, cuer SQUARES AND ROUNDS
3rd **Round-A-Bouts** Lac-A-Do Hall 7:30-9:30
Ron Woolcock, cuer ROUNDS phases 2-3
4th **Capitol Squares** Lac-A-Do Hall 7:30-10:30
Don Wood, caller, Randy Wulf, cuer SQUARES AND ROUNDS

Saturday

1st **Cougar Squares** St Francis Parish Hall, 139 Spencer Rd. Toledo
Jim Raupp, caller/cuer SQUARES AND ROUNDS 7:30-10:30
1st **Flutterwheels** Lac-A-Do Hall 7:00-10:00
Don Wood, caller, Ron Woolcock cuer SQUARES AND ROUNDS
2nd **Olympia Do-Si-Dos** Lac-A-Do Hall 7:30-10:30
Jim Hattrick, caller Joyce Sebree, cuer, SQUARES AND ROUNDS
2nd **Prairie Steppers** Oakview Grange, 2700 N. Pearl, Cent. 7:30-10:30
Don Wood, caller, Lonnie Sycks, cuer SQUARES AND ROUNDS
3rd **Harbor Haylofters** American Legion Hall 7:00-10:00
Randy & Chris Carlson SQUARES AND ROUNDS
3rd **Ruff and Ruffles** Catlin Grange 8:00-10:30
Jim Raupp, caller, Susan Healea, cuer SQUARES AND ROUNDS
3rd **Flutterwheels** Lac-A-Do Hall, Olympia, 7:00-9:30
Glenn Raiha, caller, Ron Woolcock, cuer, BASIC 51
4th **R Square D** Kelso Senior Center 7:30- 10:00
Craig Abercrombie, caller, Lonnie Sycks, cuer, SQUARES AND ROUNDS
4th **Rhythm Rounders** Lac-A-Do Hall, Olympia 6:00-9:00
Guest cuers ROUNDS phases 3-6

Sunday

Every **Double A's** Lac-A-Do Hall, Olympia 4:30-6:30
Jack Hardin, caller, Ron Woolcock, cuer ADVANCED
3rd **Square One Plus Club** Lac-A-Do Hall Olympia, 6:30-9:00
Gunter Monroe, caller, Spike Reid, cuer PLUS

Addresses for places where there is more than one dance a month

Lac-A-Do Hall 1721-46th Avenue NE, Olympia,
Catlin Grange 205 Shawnee Street, Kelso
Kelso Senior Center 106 NW 8th Avenue, Kelso
American Legion Hall 112 W. 1st Street, Aberdeen



Quite a few of the **SPOKANE AREA COUNCIL** clubs are giving lessons this fall and reports are coming in of good attendance. Hopefully the same is true for the rest of the state and our membership will increase.

The Spokane Area Council square dancers will be dancing at the Fall Folk Festival at Spokane Community College on Sunday, November 15th from 1-2 pm. Valley Cross Trailers is the contact but this is a promotion for square dancing by all area square dancers.

We are currently working with the North Spokane Dance Association on the 5th weekend dances for January. NSDA is working to get Steve Noseck for Friday night and the council is working to use him for the Saturday night dance.

Be sure to check the Spokane Area Council website at squaredancespokane.com. There is a wealth of information on this website. Our web masters, Dave and Karen Reichardt, are doing a fantastic job!

Leroy was standing at the door of the airplane receiving last minute instructions for his first parachute jump. "As soon as you jump, count to three and pull this cord. If that doesn't work, then you pull this cord. When you land, there will be a little red truck to pick you up." Leroy jumped, counted to three, pulled the cord, and nothing happened! He pulled the second cord, as instructed, and nothing happened! "Ha!" he said, "That little red truck probably won't be there either!"

Richard and Barbara Snyder

Merry Christmas Square Dancers! Come start off December by WRAPPING IT UP with the **COEURLY QS** on Saturday, December 5th! We'll have Adam Christman calling and Justine Brown cuing starting at 7 pm. for Plus with Rounds and 8 pm for Mainstream. Finger food appreciated. Hearing enhancement available. If ?? contact 208-596-3326.

Marcia Siring

Happy Holidays from the **DANCING SHADOWS!** We hope everyone has a wonderful time of fellowship with friends and family. We are participating in the Tri-club lessons, which are going well. The students are having fun and we are enjoying helping them. Our November dance was our "Teddy Bear Dance" where we collected lots of stuffed animals to donate to a local charity. We had a good time dancing to our special guest caller, Doug Davis, and our wonderful

club cuer, Carol Shopbell. Thank you to everyone who came and donated.

Our annual Christmas dance will be on Friday, December 18th. Adam Christman will be calling for us. Plus with Rounds starts at 7:00 pm and Mainstream with Rounds at 8:00pm. We hope to see you all there.

Tami Carson

DIAMOND SQUARES round dance basic class will wrap up on Monday, December 21st. Our students are learning well with the help of our friendly angels. Our annual club Christmas party and gift exchange is on December 6th at the North Spokane Dance Center. Remember to join us for the Party Dance every first Friday of the month. New dancers are most welcome. Our dance theme for our December 12th dance is "Beach Party". Join us in our imaginary island experience by wearing your hats, shades, slippers and shorts. This will be a fun dance. We start Mainstream at 7:00 pm. Our members missed the Hex set so we decided to do that to end the evening. Our caller and cuer are Bob and Claudia Amsbury, and we dance at the Western Dance Center. May the joy of Christmas bring you pleasant memories, thoughts of friends and family and much happiness. Happy holidays and enjoy the festivities, keep smiling and have fun dancing.

Nelly Christoffersen

HI-FLYERS had a very successful Halloween Dance on October 16th. With visitors from many clubs, we often had six squares on the floor and awarded three banners. We had a bubbly cauldron of cider, roving witches, and a happy time.

Once again, our new format worked well, i.e., 7:00 - 8:00 Plus squares with rounds cued to the level of those present, and 8:00-10:00 Mainstream with rounds.

We now look forward to our November dance on the 20th. It is our annual "Cake Walk" dance. We give away 8-10 mouth-watering cakes, which is at least one of the reasons it has been our most popular dance over the years.

We continue our lessons on Monday evenings, with Adam Christman teaching beginning squares at 6:30 - 8:00 and Nina Leisi teaching beginning Rounds 8:00 - 9:30.

Our dances and lessons are all at the Cheney City Hall, 609 Second St. We will hold our annual Christmas party on December 5th, hosted by Donna and Ray Pearson. However, we do not sponsor a dance in December. Instead, we will look forward to dancing with other clubs in partial repayment for the many who have visited us.

Our next dance will be January 15th, 2016 with the theme of "Winter Carnival." One of our members will be a princess.

Looking forward to seeing you on the dance floor,

Grant & Lelia Smith, leliadsmith@gmail.com

The **HOODOO VALLEY HOEDOWNERS** are enjoying a fun and successful Fall dance season.

Our Halloween barn dance was well attended and great fun. Caller Rob Krum was a “falling angel” and cuer Theresa Ray came as Princess Leia accompanied by Maddy as a Wookiee. The Hickey Farms U-Pick pumpkin patch in Sandpoint, Idaho was again our Haunted Barn dance location.

Mainstream and two-step lessons are well attended and progressing nicely.

Our next dance will be a student friendly Christmas dance at the Jewel Lake Barn on December 19th. Rick and Kathy Utter are calling /cueing. Their duets and Christmas themed music along with the decorations and setting make this dance magical.

Penny Goodman

The **JACKS & JENNY'S** had a fun Hobo Dance in October. Bob and Claudia did a good job calling and cueing for us. It is good to have our own caller and cuer. Floyd West took the 50/50 pot home in his pocket. Door prizes were won by Shawna Tomme, Mark Hocum, and Don and Valerie Kleopfel. We were saddened by the death of longtime club member, Brian Green. Our prayers go out to his wife Gabriella.

Classes are moving along and our students are doing great. Our November dance was to honor our Veterans.

Helen Knapp

The **KRAZY 8'S** are enjoying mainstream lessons with ten new students. Gary Baker is instructing the new students and it is so much fun to share in their enthusiasm and smiles when they master a new step. They are looking forward to their first party level dance. We have ages eight to adult for our current set of lessons. The youngest to the adult ladies are excited to get outfitted with square dance attire and there is much twirling of skirts going on!

We traveled to the Hi-Flyers for their Halloween dance and retrieved a banner. It was a lot of fun and they are a friendly group. We ended with a scatter promenade which is always interesting.

In November we have our baked potato dance with silent auction. It is fun to see people try to outbid each other for an item which catches their eye. December will be our Christmas dance and we will have our holiday potluck on December 6th with the mainstream and round dance students joining club members.

Adam Christman is our club Caller and most of you know how much fun he creates for the dancers. Nina Leisi is our club Cuer and her level 2 round dance classes are going well. She always cues a couple of beginner rounds so the new students can enjoy practicing their steps as well at a real dance. We invite you to come out and join us on the first Friday of each month at the Western Dance Center.

Debbie Edmiston

The **MODEL T'S** have started mainstream lessons with our caller/teacher Vern Boggs. Lessons are every Wednesday evening at 7:00 pm. We are excited to have 15 students. Holidays are fast approaching with so many creative costumes on the dance floor. Our Christmas Toy 4 Tots dance will be December 12th. Bring a toy and visit with the Marines who come to gather up the toys which will be given to children in our community. The evening begins with Plus and Rounds at 7:00 pm and Mainstream with Rounds at 8:00 pm. Happy Holidays everyone.

Charlene Weist

Merry Christmas and Happy New Year from the **STAR SHOOTERS!!** Hope most of you have your holiday shopping well under way. It's time again for our club to get ready for our special dance of the year—the New Year's Eve buffet and dance. Every year we try to make this a dance to remember with door prizes, lots of great food, festive decorations in blue and silver, a special grand prize and of course, our own New Year's baby calling, Dan Preedy! This year Dan is celebrating 30 years as our club caller so he must have started when he really was a baby! Our special guest cuer for this event is Kathy Boggs, and we look forward to ringing in the New Year with her, Vern and some more Model T's. We have our club holiday dinner on the 4th and as always we will collect donations for our charity partner, the Spokane Valley Partners. As we celebrate with family and friends, it is especially important to share our good fortune with those in need.

To all our square dance friends and family, may you touch someone's heart this season and have your own filled as well. And, get ready to dance away all those cookies in 2016!

Diane Hartley

For the **TWIN CITY TWIRLERS** the 5th Saturday dance on Halloween was fun. The Thanksgiving potluck was a great time for fellowship, and now we look forward to December and our year-end holidays. Our first dance on December 5th will be called and cued by Bill and Lorraine Kennedy. Elections for club officers for the coming year will also be held at this dance. Ed Holyoke calls a Plus dance on December 11th and our Christmas dance will be held on December 19th. Ed Holyoke also calls at that dance and Lorraine Kennedy cues. We are asking that dancers bring canned foods to be donated to the local Food Bank. All dances begin with Pre-rounds, or a Workshop at 7:30 pm and Squares at 8:00 pm. The New Year's Eve dance on December 31st features callers from the floor. Butch Suttley will MC and Lorraine Kennedy will cue. The fun begins at 8:00 pm and lasts until after midnight.

Plus and A1 lessons are held on Tuesday nights from 6:30 pm to 9:00 pm. Mainstream lessons are held on Thursday nights from 7:00 pm to 8:30 pm. Because Christmas Eve and New Year's Eve fall on Thursday this year

mainstream lessons will only be held the first three Thursdays of the month. December is a busy end to a very happy holiday season.

The Twin City Twirlers want to wish everyone a very Merry Christmas and a Happy New Year.

Kathy Boulton

What fun the **VALLEY CROSSTRAILERS** had at the October dance. With an "apple" theme, we had apple decorations, apple cobbler, apple crisp, caramel for dipping apples, and Priscilla Davis brought apple dumplings from Green Bluff for the door prizes. She and Doug also brought apples from their trees which they allowed everyone to take home with them.

The Tri-club lessons are going strong. The new students are doing well and are learning a lot.

December's theme will be "Chocolate Heaven". We had so much positive feedback from last year's chocolate fountain that we decided to do it again. Food items that can be dipped in the fountain would be appreciated in lieu of finger food. Doug Davis will be calling and Justine Brown will be cueing for this holiday celebration. As always, 3rd Saturday, Western Dance Center, 7:00-8:00 Plus and intermediate rounds, 8:00-10:00 mainstream and easy rounds.

The Valley Crosstrailers would like to wish all of our square dance friends a happy and blessed holiday season.

Chris Smith

We lost a very dear friend of ours, Barbara Blencoe, on October 17th from cancer. Please keep Jim and their family in your thoughts and prayers during this difficult time.

As president of the **WESTERN DANCE ASSOCIATION**, we write a news article for the Spokane Area Council newsletter 10 times a year. We put a square dancer's name (mystery name) at random from the subscriber list in our article. If this person sees their name in our article and notifies us, we give them one free pass to attend a designated square dance club in the Spokane Area Council. This pass is good for that person to the designated club anytime they choose to use it, no expiration, but it can only be used once. We draw the names at random from the mailing list of the Spokane Area Council newsletter. We hope this might generate more interest in the newsletter and increase attendance at dances. So far, it seems to have generated a lot of interest.

Under the direction of our building maintenance man, Jon Love, the WDA Board along with a few volunteers has been working on the roof of the Western Dance Center. The rust was removed by sanding, these spots were painted over with a galvanizing material, a coat of primer was applied, and a top coat has been applied on the south slope of the roof. A huge vote of thanks to those volunteers who have given their time helping repair the roof: Jon Love, Dennis McCorkle, Adam Christman, Harold Van Nurden, Dan Bailly, Floyd West and Richard Snyder. Also, Teri Tupper has been helping on the dining room and kitchen roof,

tightening screws and sealing cracks. Also, thanks to Doug Davis for the loan of his paint sprayer. We are especially thankful for John Hoskins and Teri Tupper for their monetary donations.

A Mississippian came home and found his house on fire, he rushed next door, telephoned the fire department and shouted, "Hurry over here. My house is on fire!" "OK", replied the fireman, "how do we get there?" "Shucks, don't you still have those big red trucks?"

Richard and Barbara Snyder

What fun the **WILD ROSE RAMBLERS** had at the October travel to Hoodoo Valley Hoedowners' dance in Hope, Idaho. It was great to dance with so many Idaho, Montana and Washington friends at Hickey Farms! Some costumes were wonderful; some outrageous. Vicki Krum's "devil" costume was REALLY CUTE on her; Rob's "angel" costume wasn't quite as cute - hee-hee! We also enjoyed dancing with a lot of friends at Star Shooters dance in September and at Diamond Squares and Spurs & Skirts dances in November.

Lessons are going well. The young lady whose name was drawn at the Interstate Fair is dancing with us (free for 12 lessons) - and is loving it! We hope that all the clubs have a successful new dancer group who can join our favorite activity.

December's dancers will enjoy the calling of Rob (Vicki) Krum and cueing of Claudia (Bob) Amsbury. The December 5th dance theme: Bid-a-Basket - it's so much fun! Guests (and members) can "win the bid" for something edible, homemade or purchased for the event. (We always have some great Christmas gift ideas!) Hope you can join us in

a square sometime soon. Dancing creates more smiles! We wish you all a Joyous Christmas and Blessed New Year!

Judy Ottoson

HARBOR HAYLOFTERS

3rd Saturday monthly except
2nd Saturday in June

Caller: Randy & Chris

Carlson

Pre Rounds 7:00
Ms Dance 8 - 10:00

NEW LOCATION

American Legion Hall

112 W 1st St. - Aberdeen, WA

TWIN CITY TWIRLERS

1st & 3rd Sat: Oct 4, 2014 thru June 6, 2015

Caller: Butch Suttley

Curer: Lorraine Kennedy

Rounds: 7:30pm - Squares: 8:00pm

(509) 758-3543 • <http://lcsq.info>

2130 5th Ave., Clarkston, WA

Prairie Steppers

2nd Saturday, 7 - 8 Plus • 8 - 10:30 Mainstream

September to May, Oakview Grange, 2715 N. Pearl, Centralia, WA 98531

DON WOOD, CALLER • LONNIE SYCKS, CUER

Chicken Dance TBA watch for ad in Footnotes

Load the Boat!

New Year's Eve (DEC. 31, 2015)

...with the SwingNuts

Square Dance Club



7:00 PM
to after
Midnight!

* Valley Dance Hall
1705 Willow St., Sumner WA

CRUISING into 2016 NEW YEAR'S EVE

~Formal Night~

Neil Diamond & Elvis Tribute

(w/ DON WOOD & JESS THOMAS)

DON WOOD - Calling

MARIE WOOD - Cueing

Come join us for a "cruise ship-themed" evening you won't soon forget! Complete with a stage show, followed by a "dessert extravaganza, 3 hours of dancing with "Donnie & Marie" (B51, M/S, Plus, with Rounds), a "NYE" toast, and midnight breakfast!

Call (253) 200-4566 or email gailj@chessmenkastle.com for
Pre-Sale Tickets: \$15 p/p (\$20 p/p at door)

Glass Slipper Ball New Year's Eve 2015



Olympia Area Square Dance Inc. Presents
Steve Noseck Calling & Randy Wulf Cueing

Lac-A-Do Hall 1721 46th Ave NE Olympia, WA.

\$15.00 Singles	8:30—9:00 Pre-Rounds	Buffet Served all Evening
\$30.00 Couples	9:00—12:30 Square Dance	Dessert & Sparkling Cider at Midnight
\$7.00 Youth	with Plus tips	Hosted by Round A-Bouts

For Tickets or Information See any OASDI member or Call Gary Gerdes 360-459-4864

Non-Profit Org.
US Postage
PAID 99324
Permit #44

SQUARE & FOLK DANCE
FEDERATION OF WASHINGTON
PO BOX 11160
YAKIMA WA 98909-2160

*Happy
Holidays!
...enjoy the
season...*



**PETTICOAT JUNCTION
DANCE SHOP**

14523 Highway 99 #1
Lynnwood, WA 98087
800-344-3262 425-743-9513

www.petticoatjct.com
email us! friends@petticoatjct.com